

---

# Web-Based Admin View Operation Guide V20

---



# Preface

This manual outlines the functions and operation of the Web-Based Admin View. Web-Based Admin View is a common base to utilize GUI (operation management view) with SynfinityCluster, and is provided along with each operation management product.

## Target Readers

This manual is intended for all users who use products that use the Web-Based Admin View (such as the Synfinity series and others).

## Organization

This manual consists of four parts, an Appendix, and glossary. The contents of each part are described below.

**Part 1 Outline of the Web-Based Admin View**

Describes the functions and operation of the Web-Based Admin View.

**Part 2 Operating the Web-Based Admin View**

Describes how to operate the Web-Based Admin View GUI screen, and the operation method (e.g. shut-down, restart) of Web-Based Admin View.

**Part 3 Common Menu**

Details the functions supported by the Common menu.

**Part 4 Changing the Setting of the Web-Based Admin View**

Describes how to change the settings of the previously installed Web-Based Admin View.

**Appendix A Messages**

Explains the messages displayed by Web-Based Admin View and the actions that must be taken.

**Appendix B Troubleshooting**

Explains how to take corrective actions in the event of a failure and collect required data for the request of troubleshooting.

**Glossary**

This part defines the terms used for the Web-Based Admin View. This part should be read as required.

## Supported Operating Systems

Solaris(TM) 2.6 OS, Solaris(TM) 7 OS, Solaris(TM) 8 OS, Solaris(TM) 9 OS and Solaris(TM) 10 OS are supported in this version.

## Manual Printing

To print this manual, use the PDF file found in the CD-ROM for each product. You will need Adobe Acrobat Reader to read and print the PDF file. Use Adobe Acrobat Reader Version 4.0 or higher.

## Notational Conventions

This document uses the following notational conventions:

- Characters to be entered by the user are indicated in bold.

- The title of lookup destination is enclosed by " ".
- Tool bar names, menu names, command names, and icon names are enclosed in brackets ([ ]).
- Instructions to select the [yy] command from the [xx] menu in the menu bar are indicated as "Select [xx]-[yy]."
- Button names are enclosed in angle brackets (< >).



- **Point** Describes the contents of an important point.



- **Note** Describes an item to be noted.



- **Example** Describes operation using an example.



- **Information** Describes reference information.



- **See** Provides the names of manuals to be referenced.
- Microsoft(R) Windows NT(R) Server operating System Version4.0 and Microsoft(R) Windows NT(R) Server workstation System Version4.0 are abbreviated as Windows NT(R).
- Microsoft(R) Windows(R) 98 operating system and Microsoft(R) Windows(R) 98 Second Edition operating system are abbreviated as Windows(R) 98.
- Microsoft(R) Windows(R) 2000 operating system is abbreviated as Windows(R) 2000.
- Microsoft(R) Windows(R) XP operating system is abbreviated as Windows(R) XP.
- Windows(R) 98, Windows NT(R), Windows(R) 2000, Windows(R) Me and Windows(R) XP are abbreviated as Microsoft(R) Windows.
- Solaris(TM) 2.6 Operating Environment is abbreviated as Solaris 2.6 OE.
- Solaris(TM) 7 Operating Environment is abbreviated as Solaris 7 OE.
- Solaris(TM) 8 Operating Environment is abbreviated as Solaris 8 OE.
- Solaris(TM) 9 Operating Environment is abbreviated as Solaris 9 OE.
- Solaris(TM) 10 Operating Environment is abbreviated as Solaris 10 OE.
- Solaris 2.6 OE, Solaris 7 OE, Solaris 8 OE, Solaris 9 OE and Solaris 10 OE are abbreviated as Solaris OE.

## Manual Printing and Binding Service

Only an online manual and PDF are provided for this version, although the manual printing and binding service is offered as normal, so that this manual can be referenced on paper. If you need a paper manual, print the PDF file of the following manual code:

Manual code: J2S1-1520-03EN

March 2005

## Trademarks

Sun, Sun Microsystems, the Sun Logo, Solaris and all Solaris based marks and logos

are trademarks or registered trademarks of Sun Microsystems, Inc. in the U.S. and other countries, and are used under license.

Netscape and Netscape Navigator are trademarks of Netscape Communications Corporation in the United States and other countries.

Microsoft, Windows and Windows NT are registered trademarks of Microsoft Corporation in the United States and other countries.

Screen images are used in accordance with the guidelines of Microsoft Corporation.

Java and all Java-related products and logs are trademarks or registered trademarks of Sun Microsystems, Inc. in the United States and other countries.

Other product names are product names, trademarks, or registered trademarks of these companies.

#### Requests

- No part of this document may be reproduced or copied without permission of FUJITSU LIMITED.
- The contents of this document may be revised without prior notice.

All Rights Reserved, Copyright(C) FUJITSU LIMITED 2001-2005



# Contents

<b>Part 1</b>	<b>Outline of Web-Based Admin View</b> .....	<b>1</b>
<b>Chapter 1</b>	<b>What is Web-Based Admin View?</b> .....	<b>3</b>
1.1	Web-Based Admin View .....	4
1.2	Cluster Topology of the Web-Based Admin View .....	5
1.2.1	Logical Three-Tier Architecture .....	5
1.2.2	System Topology .....	5
1.2.3	Operating the Secondary Management Server Dynamically .....	9
1.3	Referencing the Version or Level of the Web-Based Admin View .....	10
1.4	Product Using Web-Based Admin View .....	11
<b>Chapter 2</b>	<b>Installing Web-Based Admin View</b> .....	<b>13</b>
2.1	Initial Installation of Web-Based Admin View .....	14
2.2	Upgrading Web-Based Admin View .....	15
2.3	Setting Web-Based Admin View When Using SynfinityLink .....	16
<b>Part 2</b>	<b>Operating Web-Based Admin View</b> .....	<b>19</b>
<b>Chapter 3</b>	<b>Starting the Web-Based Admin View Menu</b> .....	<b>21</b>
3.1	Preparations for Starting the Web-Based Admin View menu .....	22
3.1.1	Determining the user group .....	22
3.1.2	Preparing the client environment .....	23
3.1.3	Preparing the Web environment .....	25
3.2	Starting the Web-Based Admin View Menu.....	30
3.3	Top Menu of Web-Based Admin View .....	32

3.3.1	Web-Based Admin View menu facilities.....	32
3.3.2	Common Menu Facilities .....	34
3.3.3	Using Operation Management Products with Different Access Methods Simultaneously.....	35
3.4	Exiting from the Web-Based Admin View Menu .....	36
3.5	Operating the Web-Based Admin View Screens .....	37
3.5.1	Tentative modification of screen display settings (Language, Look & Feel).....	37
3.5.2	Switching the Management Server to Be Connected .....	38
3.5.3	Changing the Screen Size .....	38
3.5.4	Using the Mouse.....	38
3.6	Stopping Web-Based Admin View .....	39
3.7	Restart Web-Based Admin View .....	40
3.8	Setting Operating Conditions for Web-Based Admin View.....	41

**Part 3 Common Menu .....43**

**Chapter 4 Environment setup.....45**

4.1	Environment setup start .....	47
4.2	User environment.....	48
4.2.1	Log & Inactivity timeout .....	49
4.3	System environment.....	51
4.3.1	Display setup .....	53
4.3.2	Log & Inactivity timeout .....	55
4.3.3	Primary management server .....	56
4.3.4	Secondary management server.....	57
4.3.5	Client .....	59
4.3.6	Monitoring node.....	60
4.3.7	Login log.....	61
4.3.8	Operation log .....	62
4.3.9	Event log.....	63
4.3.10	Server trace log .....	64
4.3.11	Monitoring node trace log .....	65
4.4	Node environment.....	66
4.4.1	IP address / Host name .....	67
4.4.2	Server environment .....	68
4.5	Reference and modification by command .....	69
4.5.1	Environment variable .....	69



4.5.2	Environment variable reference .....	70
4.5.3	Environment variable modification .....	70
4.6	Authentication environment setup .....	72
<b>Chapter 5</b>	<b>Web-Based Admin View log reference .....</b>	<b>73</b>
5.1	Log type.....	74
5.2	Log file display.....	75
5.2.1	Logging view startup.....	75
5.2.2	Login log .....	76
5.2.3	Operation log .....	78
<b>Part 4</b>	<b>Changing the Web-Based Admin View settings .....</b>	<b>81</b>
<b>Chapter 6</b>	<b>Changing the Settings .....</b>	<b>83</b>
6.1	Changing an IP Address on the Public LAN.....	84
6.2	Changing a Network Service Port Number .....	85
6.2.1	Changing a Http Port Number .....	85
6.2.2	Changing RMI Port Numbers.....	85
6.2.3	Changing Java Environment.....	86
6.3	Changing the management server .....	88
6.4	Changing the secondary management server automatic migration .....	90
6.4.1	Setup by command.....	90
6.4.2	Setting from environment setup screen .....	91
6.4.3	Access method .....	92
6.5	Using the Management Server in a Split-network Environment.....	93
<b>Appendix A</b>	<b>Message .....</b>	<b>97</b>
A.1	Message reference.....	97
A.2	Web-Based Admin View message .....	98
A.2.1	Information message .....	98
A.2.2	Error message .....	99

A.3	Log reference message.....	102
A.3.1	Information message .....	102
A.3.2	Error message .....	102
A.4	Environment setup message.....	102
A.4.1	Information message .....	102
A.4.2	Warning message.....	103
A.4.3	Error message .....	103
<b>Appendix B</b>	<b>Troubleshooting .....</b>	<b>105</b>
B.1	Troubleshooting.....	105
B.2	Collecting Troubleshooting Information.....	115
B.2.1	Executing the wvCntl Command.....	116
B.2.2	Collecting the Java Console .....	116
B.2.3	Collecting screen hard copies.....	117
<b>Glossary</b>	<b>.....</b>	<b>119</b>
<b>Index</b>	<b>.....</b>	<b>121</b>

# **Part 1      Outline of Web-Based Admin View**

---

---

Part 1 outlines Web-Based Admin View.



# **Chapter 1 What is Web-Based Admin View?**

---

---

This chapter outlines Web-Based Admin View.

## 1.1 Web-Based Admin View

Web-Based Admin View is a common base enabling the use of a GUI (management view) with operational management products such as SynfinityCluster management view and SynfinityDisk management view. Web-Based Admin View is provided together with each operational management product.

Web-Based Admin View provides these operational management products with the following features:

1. **Authentication function**  
The operation administrator of each management view can use each view after the authentication process provided by Web-Based Admin View. That is, an operation administrator does not need an authentication process for each operational management product or each node and is able to perform an operation simply by executing the authentication process of Web-Based Admin View.
2. **GUI view function**  
A GUI view on the client is provided for each operational management product. Since SynfinityCluster or SynfinityDisk management view displays a management / monitoring screen on the client for Web-Based Admin View, an administrator using multiple management views can always perform a desired operation from the top menu screen of Web-Based Admin View.
3. **Multiple node monitoring function**  
If multiple nodes such as SynfinityCluster nodes are to be monitored, an administrator using the management view can operate or manage all the nodes to be monitored merely by accessing the management server because the Web-Based Admin View management server monitors all object nodes.
4. **Online manual display function**  
Refers to the function for displaying the online manuals provided by each operational management product.  
The operational management products provide administrators with document information services by providing the online manual on the Web-Based Admin View at the same time as the management view.

## 1.2 Cluster Topology of the Web-Based Admin View

### 1.2.1 Logical Three-Tier Architecture

Web-Based Admin View adopts a logical three-tier architecture. The purpose of this is so that a variety of operational management products can constitute its topology freely.

The roles are explained as follows:

1. Clients  
Indicate the PC or UNIX workstations on which the management views of each operational management product provided by Web-Based Admin View are displayed. The management view provided by each operational management product is operated from the clients.
2. Management server  
The management server receives operations and display requests from the menus of the cluster management view and passes them on to the monitored nodes. If multiple monitoring nodes are available, they are administered as a whole so that all those monitoring nodes can be operated on a single screen for the clients. Management server can be duplicated, and in this case, one of the nodes becomes the primary management server, and the other becomes the secondary management server.  
In particular, if the cluster management view provided by SynfinityCluster is used, the management server is always dualled and the entire cluster system can be administered using the job takeover node as the secondary management server, even if the operation node that is used as the primary management server fails.
3. Monitoring node  
Monitors or performs settings for a management server request. Also, monitors a variety of phenomena that occur in the nodes after system startup and notifies the management server if an error occurs.

### 1.2.2 System Topology

The clients, management server, and monitoring nodes of Web-Based Admin View can be allocated freely.

The topology of each is explained below.

Note that the topology to be supported varies depending on the operational management product. For details, see the document for each operational management product.



#### Note

- For details about setting the management server, refer to 6.3 "Changing the management server."
- For details about setting network environment of management server, refer to 6.5 "Using the Management Server in a Split-network Environment."

1. Single architecture model

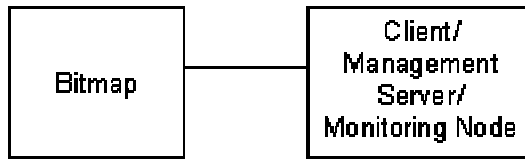

Topology in which the nodes to be monitored, the management server, and clients are used with a single node at the same time.

2. 2-tier architecture model

In this model, one tier is shared by a management server and a monitoring node; the client is independent.

This model is relatively small and is used when a management server is not set for specific purposes. This model is a typical model that is primarily in a cluster topology such as 1:1 standby or mutual standby in a two-node configuration.

This model supports two types of topology, which are described below.

— Topology where a network is shared

In this topology, a LAN is used as a public LAN and as a LAN from a Web browser of a management client. This topology should be adopted if the user and network range must be limited.

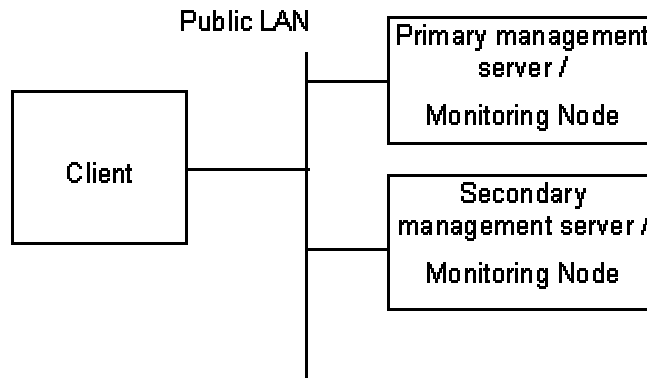

— Topology where separate LANs are used

In this topology, a public LAN and LAN used from a Web browser of a management client are used separately. When using a management client from a public network, this topology is recommended for security.

When performing setup, specify both the IP address that is used for clients and the IP address that is used for a monitoring node on the administration server. For details on the cluster system, see the "SynfinityCluster Installation/Administration Guide."

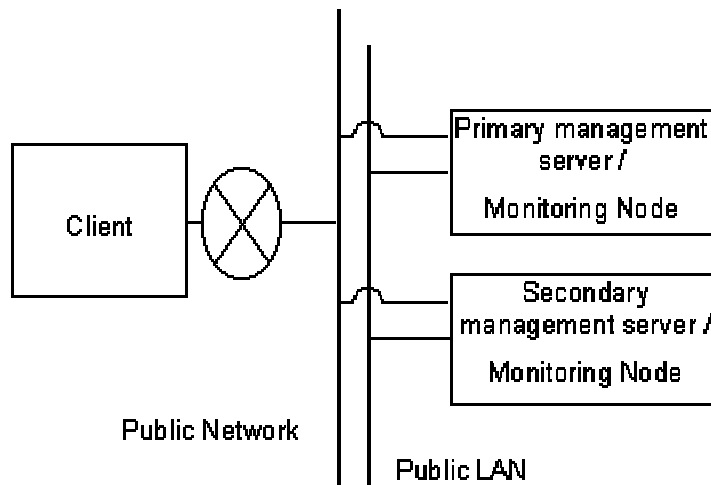



## 3. 3-tier architecture model

In the three-tier model, clients, management servers, and monitoring nodes are set up separately.

Use this model for overall management of a large SynfinityCluster system, and a monitoring node should be relieved of its load as a management server. In the case of the cluster system, this model is for N:1 standby, mutual standby, or scalable operations in a configuration having three or more nodes.

For a configuration with three or more nodes, Fujitsu recommends use of the 3-tier architecture model in which the management server is installed separately to assure job continuity and availability.

This model supports two types of topology, which are described below.

— Topology where a network is shared

In this topology, a LAN is used as a public LAN and as a LAN from a Web browser of a management client. This topology should be adopted if the user and network range must be limited.

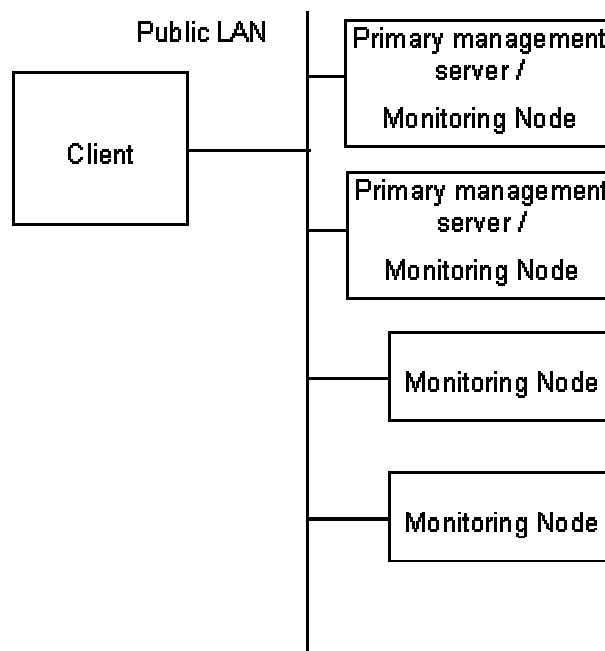

— Topology where separate LANs are used

In this topology, a public LAN and LAN used from a Web browser of a management client is used separately. When using a management client from a public network, this topology is recommended for security.

When performing setup, specify both the IP address that is used for a monitoring node and the IP address that is used for a client node on the administration server. For details on the cluster system, see the "SynfinityCluster Installation/Administration Guide."

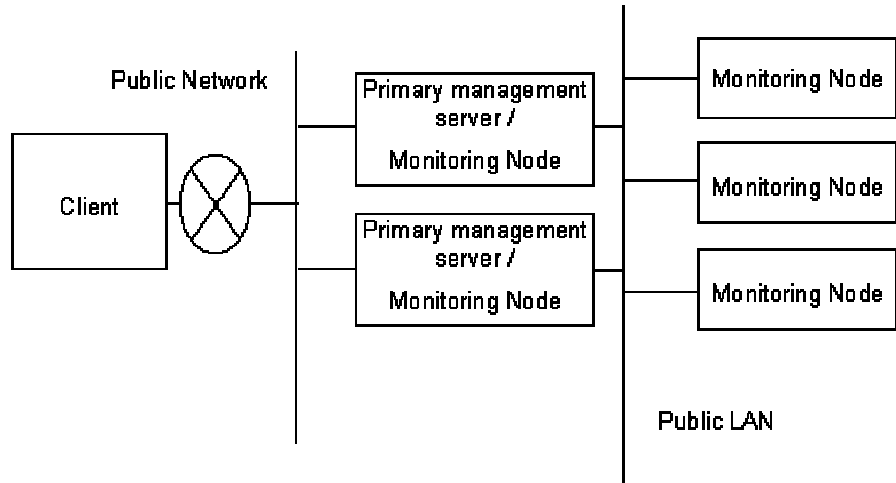

**Note**

If you are using SynfinityCluster/HA for Netcompo, the setup object cluster node must be directly accessible from the clients. Be particularly careful when a network is to be separated.



**Point**

The network being used by Web-Based Admin View is referred to as a public LAN. The clients, management servers, and monitoring nodes of Web-based Admin View communicate with each other by using an IP address that is assigned to the network card connected to the public LAN. This IP address is called the “IP address of public LAN” in this manual.

### 1.2.3 Operating the Secondary Management Server Dynamically

With the Web-Based Admin View, the secondary management server can automatically be changed during operation depending on the operating status of the entire cluster system.

If the secondary management server has failed, or if both the primary and secondary management servers have failed, one unit is selected from the other running monitoring nodes. The single selected monitoring node either takes over the function of the secondary management server or becomes the secondary management server itself.

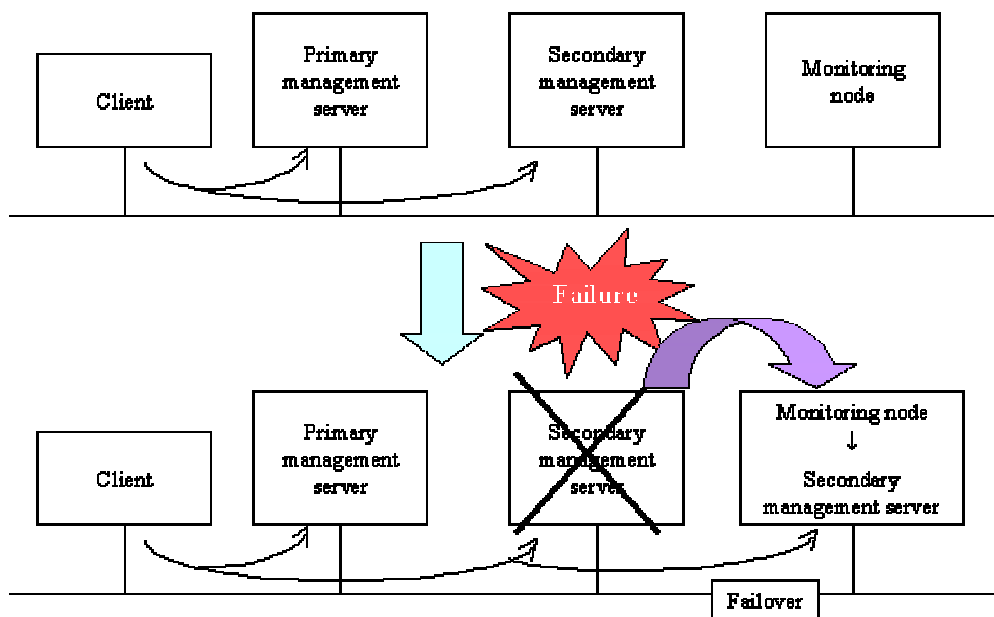

Two or more monitoring nodes can be set up as candidates to be operated as secondary management servers. Each monitoring node must be set as being a candidate secondary management server.

Note that, when two or more candidates are set, secondary management servers are selected and determined fundamentally from the running monitoring node in descending order of IP addresses that are set up for the public LAN.

For details of the settings with which the secondary management server is dynamically operated, refer to 6.4 "Changing the secondary management server automatic migration."

## 1.3 Referencing the Version or Level of the Web-Based Admin View

The version of the Web-Based Admin View is automatically updated when each product is installed.

To reference the version or level of the Web-Based Admin View that is currently installed, perform the following:

- Confirm with the top menu of the Web-based Admin View.  
From the client, access the management server and then select [Version] that is displayed in the upper right corner of the top menu.

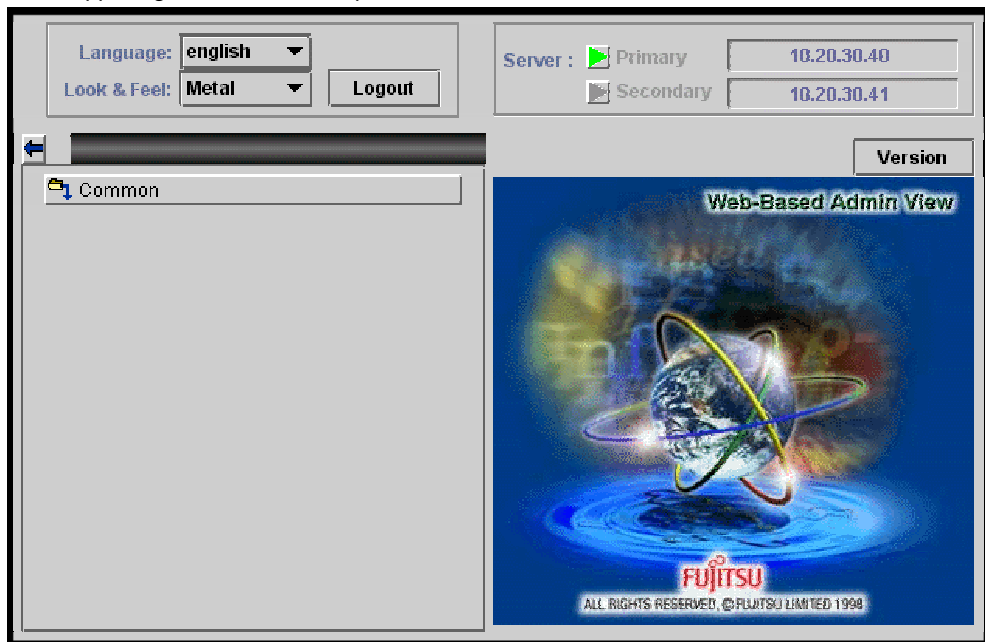

- Confirm by command execution.  
From the node on which Web-Based Admin View is installed, execute the following command and confirm the version or level that appears:  
`# /etc/opt/FJSVwvbs/etc/bin/wvversion`
- The current version is displayed as below.

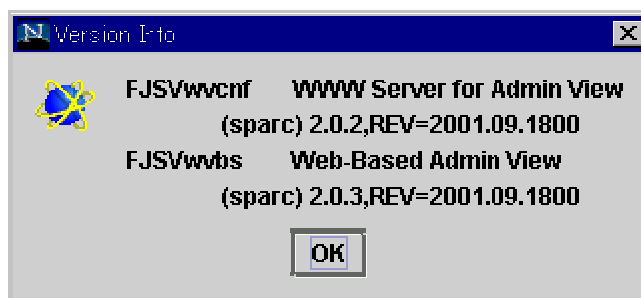

### Note

The version of Web-Based Admin View is specified next to the parenthesis.

## **1.4 Product Using Web-Based Admin View**

The operations management products that are supported by the the Web-Based Admin View version of this manual are as follows:

- SynfinityCluster
- Machine administration
- SynfinityDisk
- SynfinityFile/Global
- SynfinityFile/Global POWER Edition
- Multipath Disk Control



## **Chapter 2 Installing Web-Based Admin View**

---

This chapter outlines the operating environment and subsequent upgrading of Web-Based Admin View.

The initial installation of Web-Based Admin View is performed at the same time as the installation of each operation management product.

For details, refer to the documentations related to the installation of each operation management product.

## 2.1 Initial Installation of Web-Based Admin View

The management server and the monitoring node of Web-Based Admin View support the following prerequisite environment:

- Hardware  
GRANPOWER 7000F, PRIMEPOWER
- Memory  
128MB or more memory is necessary.
- Operating system  
**Solaris2.6, Solaris7, Solaris8, Solaris9, or Solaris10**
- Prerequisite software  
**Java Runtime Environment (Java bundled in Solaris OE)**  
(Operation with /usr/java1.1, bundled with Solaris, is guaranteed.)
- Necessary HDD disk space  
For the standard configuration, 7 MB of disk space is required. Another 32 MB of space is necessary if the number of collections or the size of each trace information item is maximized in the Environment Setting to collect more detailed information.



[See](#)

Refer to 3.1.2 "Preparing the client environment" for details of prerequisite environment for the client of Web-Based Admin View.



## 2.2 Upgrading Web-Based Admin View

Web-Based Admin View is upgraded for the management server and the monitoring node at the same time as the operation management products.

For details, refer to the documentation for each operation management product listed up as **Operation management product name** of 3.3.1 "Web-Based Admin View menu facilities."

## 2.3 Setting Web-Based Admin View When Using SynfinityLink

You must set up Web-Based Admin View, as described below, after setting up Fast Switching mode on SynfinityLink:

### ◆ Operation Procedure:

1. Set up a public LAN IP address

While referring to 6.1 "Changing an IP Address on the Public LAN", set the public LAN IP addresses of all the management servers and monitoring nodes to the virtual IP addresses that are used for SynfinityLink.

2. Set up a management server

If the changed monitoring node is a cluster management server, refer to the "SynfinityCluster Installation/Administration Guide V2.0" and apply the setup method for changing the management server to change the cluster management server.

3. Set up clients

- If clients are Windows(R) PC

Define the following from the MS-DOS prompt/command prompt of the two units running Windows(R) 98/Windows NT(R):

```
C:\Windows>route add <virtual IP address A> MASK <subnet mask> <IP address A>
C:\Windows>route add <virtual IP address B> MASK <subnet mask> <IP address B>
```

- If the clients are Solaris Workstations or System Management Console(SMC)

Define the following for each of the two Clients:

```
# route add host <virtual IP address A> <IP address A>
# route add host <virtual IP address B> <IP address B>
```

#### Virtual IP address A, IP address A

Of the virtual IP addresses defined with SynfinityLink on the primary management server, and of the IP addresses that correspond to the physical interface names that are bundled with those IP addresses, that which is connected to the same network as the client

#### Virtual IP address B, IP address B

Of the virtual IP addresses that are defined with SynfinityLink on the secondary management server, and of the IP addresses that correspond to the physical interface names that are bundled with those virtual IP addresses, that which is connected to the same network

#### Subnet mask

255.255.255.255 is set up.



#### Note

Since information that is set up with the route command is deleted if the client is re-IPL, Fujitsu recommends that you register it in a batch file or log procedure or elsewhere in the startup folder.

4. Example of setting

The following is an example of setting using the wvSetparam and wvSetup commands in the following environment:

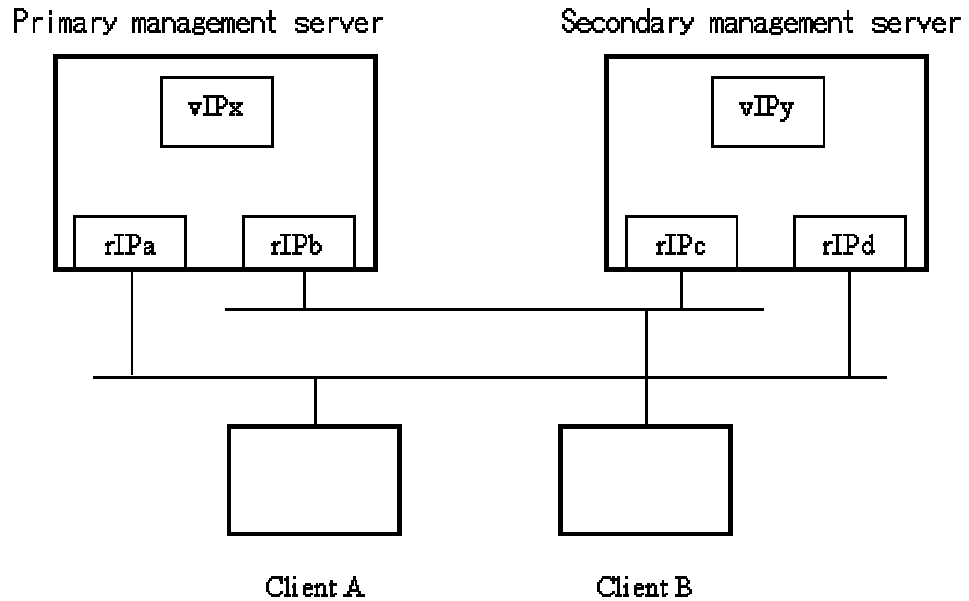

vIPx, vIPy : Virtual-IP-address

rIPa, rIPb : Physical interface names to be bundled with virtual-IP-addresses  
rIPc, rIPd

- a) Setup with the primary management server
 

```
# /etc/opt/FJSVwvbs/etc/bin/wvSetparam mip <vIPx>
# /etc/opt/FJSVwvbs/etc/bin/wvSetparam httpip <vIPx>
# /etc/opt/FJSVwvbs/etc/bin/wvSetup <vIPx> <vIPy>
# /etc/opt/FJSVwvbs/etc/bin/wvCntl restart
# /etc/init.d/fjsvwvcnf restart
```
- b) Setup with the secondary management server
 

```
# /etc/opt/FJSVwvbs/etc/bin/wvSetparam mip <vIPy>
# /etc/opt/FJSVwvbs/etc/bin/wvSetparam httpip <vIPy>
# /etc/opt/FJSVwvbs/etc/bin/wvSetup <vIPx> <vIPy>
# /etc/opt/FJSVwvbs/etc/bin/wvCntl restart
# /etc/init.d/fjsvwvcnf restart
```
- c) Setup with client A
 

```
C:\Windows> route add <vIPx> MASK 255.255.255.255 <rIPa>
C:\Windows> route add <vIPy> MASK 255.255.255.255 <rIPd>
```
- d) Setup with client B
 

```
C:\Windows> route add <vIPx> MASK 255.255.255.255 <rIPb>
C:\Windows> route add <vIPy> MASK 255.255.255.255 <rIPc>
```



# **Part 2      Operating Web-Based Admin View**

---

---

This section explains how to start the Web-Based Admin View.  
This manual is intended for all users of the Web-Based Admin View.



## **Chapter 3 Starting the Web-Based Admin View Menu**

---

This chapter explains how to start the Web-Based Admin View.

After user names for all nodes have been registered, check which Web-Based Admin View facilities are required by each user, and register the users to the appropriate user groups.

## 3.1 Preparations for Starting the Web-Based Admin View menu

Start up the top menu of the web-Based Admin View in the following procedure:

- Determine the user group
- Prepare the client environment
- Prepare the Web environment

### 3.1.1 Determining the user group

To use Web-Based Admin View, you must first create a user group administered by the operating system for all those nodes on which Web-Based Admin View is installed and register a user name. A unique user group name is specified for each management product. A user can limit the range of operation by the user by registering a user name to the user group that is specified by each management product to be used.

#### 3.1.1.1 User Group Types

---

For details on the user group to be created, refer to the manual for the operation management product.

The following explains the user group with which the functions provided as the Web-Based Admin View become available.

- **wvroot**

"wvroot" is a Web-Based Admin View administrator group. When the Web-Based Admin View is installed, it is created automatically. A user can operate all kinds of operation management products running on Web-Based Admin View, such as operating environment setup, log display, etc.

Also, the users belonging to the system administrator (root) can use all kinds of operation management products running on the Web-Based Admin View.



**Note**

As users who belong to wvroot have authority equivalent to those who belong to the system administrator group, you need to register a user group with sufficient care.

#### 3.1.1.2 Registering to a User Group

---

Use commands to register user names into the user groups.



**Point**

Register the user name first, and then, follow up with registration into the user group. The system administrator should initially install by the user name "root."



**Note**

It's not recommended that the user be registered into the wvroot group as the Supplementary Group. In case of registration as a Primary Group, the registration needs to be redone when Web-Based Admin View is uninstalled and installed again.

Input user name "wvroot" into the group name as Supplementary Group, and execute the following



command.

- Adding a user group for a registered user  
# `usermod -G wvroot <user name>`
- Registering a new user  
# `useradd -G wvroot <user name>`

## 3.1.2 Preparing the client environment

The client's hardware, OS, and Web browser types supported by the Web-Based Admin View are shown below:

- **PC client**
  - CPU  
Equivalent to Pentium II 233 MHz or higher
  - Memory  
96 MB or more
  - OS  
Windows(R) 98, Windows NT(R), Windows(R) 2000, Windows(R) Me or Windows(R) XP



### Note

There are some restrictions in the display environment of Japanese. For details, refer to "Note" below.

- Web browser  
Netscape Communicator 4.5 - 4.7X, Netscape 7.X or Internet Explorer 5.0 or higher (Java Plug-in is required)
- Java Plug-in  
Java(TM) 2 Runtime Environment Standard Edition Version 1.3.1  
Java(TM) 2 Runtime Environment Standard Edition Version 1.4.2
- Display unit  
800 x 600 dots or higher, supports high color (16 bits, 65,536 colors) display
- **System Management Console (SMC) or Solaris Workstation**
  - Web browser  
Netscape Communicator 4.5 - 4.7X, Netscape 7.X  
In case of using Java Plug-in, use the Netscape Communicator 4.72 - 4.7X or Netscape 7.X.
  - Java Plug-in  
10.1.2.2,REV=1999.12.06.10.02 or higher  
20.1.2.2,REV=1999.10.14.18.04 or higher  
Java(TM) 2 Runtime Environment Standard Edition Version 1.3.1  
Java(TM) 2 Runtime Environment Standard Edition Version 1.4.2

For details on the supported OS and Web browser, see the manual provided with each operation management product.



### Note

- To use the Web-Based Admin View on Japanese mode, it is necessary to meet the following conditions as OS environment.
  - The Windows(R) in Japanese version is installed.
  - The language used for Windows(R) is set in Japanese.
 In the environment other than the above conditioned, the garbled characters might occur when "japanese" is set as a displayed language of Web-Based Admin View.

- The conditions of the Web browser (including Java Plug-in) and clients are vary depending on each operation management product. For details, refer to the documentation of the management product.
- The Web browser might not work properly depending on its version. In such a case, use the latest version.
- Use the format, "http://<host name> or <IP address>:<port number>/Plugin.cgi" for the URL designation on the Internet Explorer. If the product is unavailable to Java Plug-in, use Netscape Communicator.
- It is necessary to apply the following patch when Java Plug-in 10.1.2.2 used on Solaris 2.6 or Solaris 7.

**<Solaris 2.6>**

105490-07, 105568-13, 105210-19, 105181-14, 105633-21, 105669-07

**<Solaris 7>**

106980-04, 107078-10

- It is necessary to apply the following patch when Java(TM) 2 Runtime Environment Standard Edition Version 1.3.1 or Java(TM) 2 Runtime Environment Standard Edition Version 1.4.2 used on Solaris OS.

**<Solaris 2.6>**

105181-39, 105210-52, 105568-26, 105591-20, 105633-64, 105669-11, 105284-50, 106040-18, 106123-05, 106125-16, 106409-01, 106841-01, 106842-09, 107733-11, 108091-03, 112542-01

**<Solaris 7>**

106300-24, 106327-23, 106541-38, 106950-24, 106980-26, 107081-56, 107153-01, 107226-19, 107544-03, 107636-10, 107656-11, 107702-12, 107834-04, 108374-07, 108376-44

**<Solaris 8>**

108434-18, 108435-18, 108528-29, 108652-89, 108773-19, 108921-23, 108940-68, 108987-15, 108989-02, 108993-40, 109147-32, 109326-16, 110386-03, 110615-13, 111023-03, 111111-04, 111308-05, 111310-01, 111317-05, 112003-03, 112396-02, 112438-03, 112472-01, 113648-03, 113886-27, 113887-27, 115827-01, 116602-01

**<Solaris 9>**

112785-45, 112963-17, 113096-03, 113886-27, 113887-27

**<Solaris 10>**

113886-27, 113887-27

The following error message appears when patch is not applied.

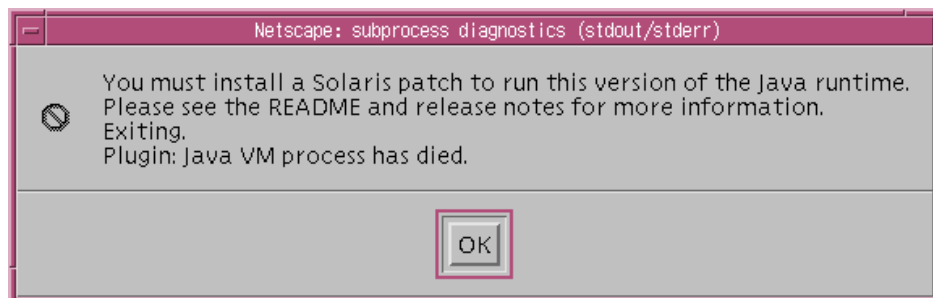

See

- For the operating environment of the management server or the monitoring node, refer to 2.1 "Initial Installation of Web-Based Admin View."

- For details on the Java Plug-in settings, refer to 3.1.3.2 "Required for the Web Browser Environment".

### 3.1.3 Preparing the Web environment

This section explains how to perform setup and how to use the Web browser, as follows:

Use the following procedure to prepare the client:

- Prepare the Web browser.
- Setup required for the Web browser environment.

#### 3.1.3.1 Preparing the Web browser

A Web browser must be prepared for the client.

As the supported OS and Web browser varies depending on each management product, first check the manual of each management product.

For the basic browser supported for Web-Based Admin View, see the item, 3.1.2 "Preparing the client environment".

The installation method and environment definitions of each browser are given in the manual supplied with the browser.

The Web-Based Admin View uses a Web browser cookie to identify the client.

For details the setting related to the handling of cookies, follow the instructions in the manual provided with the browser.

The following explains the settings for using Netscape Navigator:

#### ◆ Netscape Navigator setting procedure

1. Select [Preferences] from the [Edit] menu of the Web browser.
2. Select [Advanced] in Category.
3. Select [Accept all cookies] in the "Cookies" menu.
4. Uncheck [Warn me before accepting a cookie].
5. Select [OK].

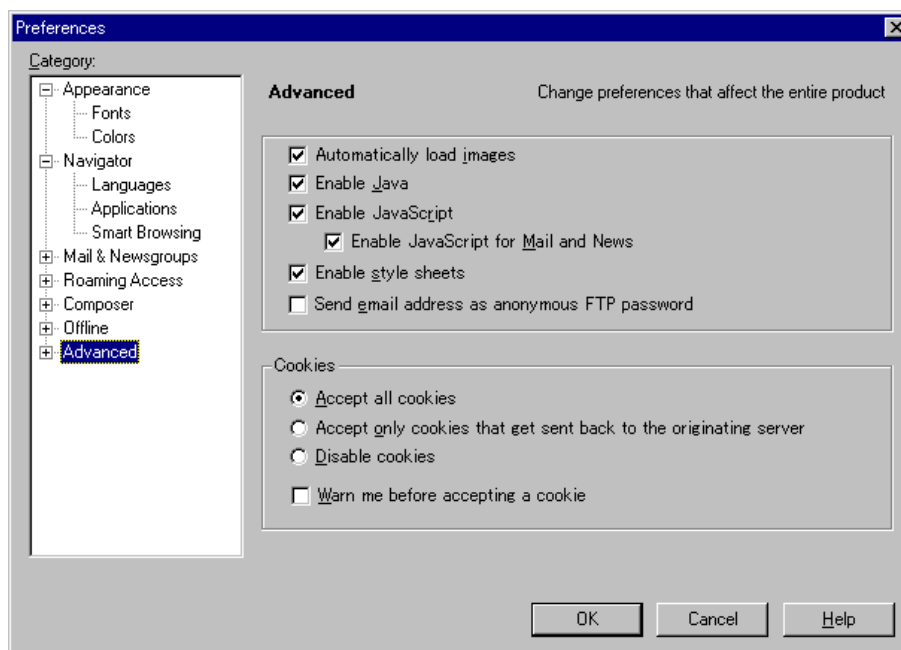

This completes the settings related to cookies.

Perform the following confirmation work.

■ **Proxy setting**

◆ **Netscape Communicator setting procedure**

1. Select [Preferences] from the [Edit] menu of the Web browser.
2. Select [Proxies] in the [Advanced] category.
3. Select [Direct connection to the Internet].
4. Click [OK].

◆ **Internet Explorer setting procedure**

1. Select [Internet Options] from the [Tools] menu of the Web browser.
2. Select the [Connections] tab, on the [Internet Options] screen.
3. In the LAN setting area, click the [LAN setting] button.
4. Unlock all the check boxes on the [Local Area Network (LAN) settings] screen.
5. Click [OK] on the [Local Area Network (LAN) settings] screen.
6. Click [OK] on the [Internet Options] screen.

■ **Confirming the Swing Class File Version**

The Swing class file used for this software is updated from that provided with the previous version. If the Swing class file provided by the previous version is found on the clients, delete the following files:

swingall.jar and base.jar

which are included in the *Netscape Communicator/Navigator installation directory*  
\\Netscape\\Communicator\\Program\\Java\\Classes

This completes the setup of the Web browser. In the following explanations, change the settings as required depending on your Web browser environment.

---

### 3.1.3.2 Required for the Web Browser Environment

---

If you are using Netscape Communicator, you can use Web-Based Admin View only by preparing this Web browser for the client. Note that Web-Based Admin View supports the following environment in accordance with the user's Web browser environment:

**[Java Plug-in environment]**

Use Java Plug-in for the following:

- If a Java Plug-in is essential to the operation management product to be used.
- If Internet Explorer is to be used for the Web browser.
- If you want to shorten the time required for the top menu to be displayed after accessing it from the client.

The supported Java Plug-in versions are clarified in 3.1.2 "Prerequisite client environment". Java Plug-in, which Sun Microsystems provides for free, may come with some operation management product packages.

When you make these settings, follow the procedure described in "Setting up Java Plug-in."

**[Setting up the Swing class file on the client]**

To shorten the time required to display the top menu without using a Java Plug-in, you can set up the Swing file on the client.



**Note**

- This method was provided in the previous version. You must replace the Swing class file because the version of the Swing class file is updated with this version.
- Support of this method varies depending on each operation management product. For details, see the manual for the management product to be used.
- This method can be used only when you are using Netscape Navigator. Note that you

cannot use this method with Internet Explorer.

- This method may not operate normally if it is used simultaneously with a Java Plug-in environment.

This software includes the Swing 1.0.3 class file distributed by Sun Microsystems, Inc. free of charge.

To make the settings, follow the procedure given in "Setting up the Swing class file".

## ■ Setting up Java Plug-in

### ◆ PC client

1. Check if Java Plug-in is installed.  
Start [Add or delete Application], and then check if the following Java Plug-in is installed it is not necessary to install.
  - Java 2 Runtime Environment Standard Edition v1.3.1
  - Java 2 Runtime Environment Standard Edition v1.4.2
2. Install Java Plug-in.  
Execute the following Java Plug-in installer in a CD-ROM.
  - For Java 2 Runtime Environment Standard Edition v1.3.1  
<CDROM drive name>: \plugins\win\j2re\_1\_3\_1-08-win-i.exe
  - For Java 2 Runtime Environment Standard Edition v1.4.2  
<CDROM drive name>: \plugins\win\j2re\_1\_3\_1-08-win-i.exe
 Install following the procedure displayed on the screen.  
This completes the setup.

### ◆ System Management Console (SMC) or Solaris Workstation

The setup procedure varies depending on the version of Java Plug-in as follows;

- **Java(TM) 2 Runtime Environment, Standard Edition Version 1.3.1**
  1. Copy Java(TM) 2 Runtime Environment, Standard Edition Version 1.3.1 for Solaris OE to the working directory from CD-ROM.  
Set up CD-ROM on the CD-ROM device.  
# `cd <CDROM1-mountpoint>/misc/j2re-1_3_1`  
Normally, <CDROM1-mountpoint> will be /cdrom/cdrom0  
When the working directory is /var/tmp:  
# `cp <CDROM1-mountpoint>/misc/j2re-1_3_1/j2re-1_3_1_15-solaris-sparc.sh /var/tmp`
  2. Make sure that the execute permissions are set on the self-extracting binary.  
# `chmod +x j2re-1_3_1_15-solaris-sparc.sh`
  3. Move directory to the location where the files should be installed.  
# `cd <Installed directory>`
  4. Run the self-extracting binary.  
A directory called j2re1\_3\_1\_15 is created in the current directory. This directory can be renamed at user's discretion after installation.
  5. Set up the environment variable  
Execute the following command to set the environment variable to the shell variable:  
[For C shell]  
# `setenv NPX_PLUGIN_PATH <Java Plug-in path>`  
[For shell and Kornshell]  
# `NPX_PLUGIN_PATH= <Java Plug-in path>`  
# `export NPX_PLUGIN_PATH`  
<Java Plug-in path> is designated the following directory containing the javaplugin.so file.  
<Installed directory>/j2re1\_3\_1\_15/plugin/sparc/ns4

Example : When *<Installed directory>* is /var/tmp  
*<Java Plug-in path>*=/var/tmp/j2re1\_3\_1\_15/plugin/sparc/ns4

6. Start your Netscape browser, or restart it if it is already activated.
7. Restart your browser again. The browser needs to be restarted twice to avoid the Netscape problem.

- **Java(TM) 2 Runtime Environment, Standard Edition Version 1.4.2**

1. Copy Java(TM) 2 Runtime Environment, Standard Edition Version 1.4.2 for Solaris OE to the working directory from CD-ROM.

Set up CD-ROM on the CD-ROM device.

```
# cd <CDROM1-mountpoint>/misc/j2re-1_4_2
```

Normally, *<CDROM1-mountpoint>* will be /cdrom/cdrom0

When the working directory is /var/tmp:

```
# cp <CDROM1-mountpoint>/misc/j2re-1_4_2/j2re-1_4_2_07-solaris-sparc.sh /var/tmp
```

2. Make sure that the execute permissions are set on the self-extracting binary.

```
# chmod +x j2re-1_4_2_07-solaris-sparc.sh
```

3. Move directory to the location where the files should be installed.

```
# cd <Installed directory>
```

4. Run the self-extracting binary.

A directory called j2re1.4.2\_07 is created in the current directory. This directory can be renamed at user's discretion after installation.

5. Set up Java Plug-in

- For Netscape Communicator 4.5 - 4.7X

Execute the following command to set the environment variable to the shell variable:

[For C shell]

```
# setenv NPX_PLUGIN_PATH <Java Plug-in path>
```

[For shell and Kornshell]

```
# NPX_PLUGIN_PATH= <Java Plug-in path>
```

```
# export NPX_PLUGIN_PATH
```

*<Java Plug-in path>* is designated the following directory containing the javaplugin.so file.

```
<Installed directory>/j2re1.4.2_07/plugin/sparc/ns4
```

Example : When *<Installed directory>* is /var/tmp

```
<Java Plug-in path>=/var/tmp/j2re1.4.2_07/plugin/sparc/ns4
```

- For Netscape 7.X

Create symbolic link from a library file.

```
# cd <netscape7 directory>/Plugins
```

```
# ln -s <Java Plug-in path>/libjavaplugin_oji.so .
```

*<Java Plug-in path>* is designated the following directory containing the libjavaplugin\_oji.so file.

```
<Installed directory>/j2re1.4.2_07/plugin/sparc/ns610
```

Example: When *<Installed directory>* is /var/tmp

```
<Java Plug-in path>=/var/tmp/j2re1.4.2_07/plugin/sparc/ns610
```

6. Start your Netscape browser, or restart it if it is already activated.

If you use Netscape Communicator 4.5 - 4.7X, restart your browser again. The browser needs to be restarted twice to avoid the Netscape problem.

- **Other version**

1. Confirm that Netscape Communicator is installed.
2. Confirm that the Java Plug-in has already been installed.

```
# pkginfo -l SUNWj2pi
```

Execute the above command. If the version is newer than below, it is not necessary to install.

If it is older than below, install Java 2 Runtime Environment Standard Edition v1.3.1 or Java 2 Runtime Environment Standard Edition v1.4.2.

VERSION: 10.1.2.2,REV=1999.12.06.10.02

VERSION: 20.1.2.2,REV=1999.10.14.18.04



#### Note

- If the version of the installed Java Plug-in is older than that described above, install an up-to-date version.
- The Java Plug-in must be installed after the Web browser. If you uninstall the Web browser after installing the Java Plug-in, temporarily uninstall and then reinstall the Java Plug-in.
- Some versions of the Windows(R) Java Plug-in may leave a cache file in the client's system directory. Fujitsu recommends that you delete these cache files periodically using the likes of the disk cleanup function.

### ■ Setting up the Swing class file

Use the following procedure to set up the Swing class file on the Web browser.

1. Acquiring the Swing class file

Before setting up the Swing class file on the Web browser, create an appropriate work directory on the client. Then, copy the file "swingall.jar" on the management server to the work directory.  
/opt/FJSVwvbs/etc/jars

#### [Downloading the jar file from the management server]

1. On the client, launch an MS-DOS prompt.
2. Move to the work directory on the client.
3. Use the ftp command to access the Cluster management server.

```
C:\> ftp host-name
```

4. Enter the user ID and password.

```
User (<host-name>:(none)):user-ID
```

```
331 Password required for user-ID.
```

```
Password:*****
```

5. Set binary mode.

```
ftp> bin
```

6. Move to the following directory:

```
ftp> cd /opt/FJSVwvbs/etc/jars
```

7. Download the file "swingall.jar."

```
ftp> get swingall.jar
```

8. Quit ftp.

```
ftp> bye
```

2. Set up the Web browser.

Copy swingall.jar, previously copied to the work directory, to the following location:  
%Netscape-installation-directory%\Netscape\Communicator\Program\Java\classes

## 3.2 Starting the Web-Based Admin View Menu

When all preparations have been made, start the Web-Based Admin View menu.

### ◆ Operation:

1. Start the Web browser in the client.
2. Specify the following URL to access the management server:

— **When not using the Java Plug-in:**

`http://<host name>:<port number>/WebView.html`

Note) In case of using above URL, use Netscape Communicator since Internet Explorer is not available. See the Note below.

— **When using the Java Plug-in:**

`http://<host name>:<port number>/Plugin.cgi`

— **When setting up the Swing class file:**

`http://<host name>:<port number>/Swing.html`

Note) In case of using above URL, use Netscape Communicator since Internet Explorer is not available. See the Note below.

**<host name>**

Host name or public LAN IP address of the primary or secondary management server

**<port-number>**

Specify "8081." If the port number was changed according to 6.2.1 "Changing a Http Port Number," specify the port number.



**Note**

- If you cannot open the menu for Web-Based Admin View when you specify a *<host name>*, specify the IP address of the public LAN directly.
  - You must be particularly careful because the method of access may vary depending on the operation management product. When you wish to simultaneously use operation management products that employ different access methods, see 3.3.3 "Using Operation Management Products with Different Access Methods Simultaneously."
  - In case of using the following URL, use Netscape Communicator since Internet Explorer is not available.
    - `http://<host name>:<port number>/WebView.html`
    - `http://<host name>:<port number>/Swing.html`
- When Internet Explorer is used, the message 0040 is displayed.
3. When the Web-Based Admin View is started, the following user name input screen will be displayed:

Enter a user name and password registered in the management server and then select [OK].







**Note**

This screen cannot be closed by clicking the [X] button of upper-right corner in the screen.

4. When certification terminates, the top menu of the Web-Based Admin View will be displayed.



**Note**

- The screen of some browsers may hang.
  - Restart the browser, then reconnect to the URL that the browser was connected to if the browser window disappears.
  - Reread the URL or restart the browser if the browser does not work (no response.)
  - The operation can be continued after the Web-Based Admin View is started by moving the mouse on the browser if the page switches to a black screen.
- If the URL of the Java Plug-in is read with Netscape Communicator or Netscape Navigator, a message stating "Click here to get the plugin" may appear. In this case, the Java Plug-in may not be installed or a version older than supported Java Plug-in may be installed. Therefore, install the Java Plug-in as explained in "Setting up Java Plug-in" in 3.1.3.2 "Required for the Web Browser Environment". Note that if you click the "Click here to get the plugin" icon, a dialog box reading "Plug-in is not read" appears. Select [Cancel].
- If "Welcome to Web-Based Admin View" does not appear after you read the URL of the Java Plug-in with Internet Explorer, an appropriate Java Plug-in may not be installed. Confirm that an appropriate Java Plug-in is installed by selecting [Start]-[Settings]-[Control Panel]-[. Add or delete application]. If none is installed, install the Java Plug-in as explained in "Setting the Java Plug-in" in 3.1.3.2 "Required for the Web Browser Environment". Also, if the "security warning" dialog box appears, and prompts you to specify whether the "Java Plug-in" is to be installed and executed, select [No].
- If dynamic operation of the secondary server is set to "changing the operation of the secondary management server," the primary management server or secondary management server that is active at this time may be automatically connected even if you specify the URL of the specific monitoring node. For details, see 6.4 "Changing the secondary management server automatic migration."
- Do not use the [Forward] or [Back] button of the browser to change the pages after the top menu of Web-Based Admin View has started.
- If the authentication is failed several times at Step 3, the message 0016 is displayed, and the login process is disabled. Refer to "Corrective action 3" of "Symptom 18" in Appendix B "Troubleshooting."

## 3.3 Top Menu of Web-Based Admin View

When you start Web-Based Admin View, the Web-Based Admin View operation screen appears. The top menu of the Web-Based Admin View is the Web-Based Admin View operation menu. The functions supported by the Web-Based Admin View operation menu are shown below:

### 3.3.1 Web-Based Admin View menu facilities

The Web-Based Admin View menu supports the following facilities. Each menu facility is outlined in "Web-Based Admin View menu outline."

#### Web-Based Admin View menu



#### Web-Based Admin View menu outline

- **Operation Management product name**  
Outline: Button used to start the management screen of the installed operation management product. For details, see the document describing each operation management product.
- **Common**  
Outline: Provides Logging View, Environment Setup, and online manual for the Web-Based Admin View.



#### Note

- The Web-Based Admin View menu depends on the products installed. You must be particularly careful when using products with different access methods because the startup menu of the products may not be displayed. For details, see 3.3.3 "Using Operation Management Products with Different Access Methods Simultaneously."
- If a dialog is displayed because of a Web-Based Admin View error, the picture on the right of the top menu of the Web-Based Admin View also turns red. Clicking the red picture moves any hidden dialog to the front. To learn of any errors, be sure the picture at the right of the top menu Admin View is always displayed.



**Point**

- The following message may be output if either operation menu is selected:

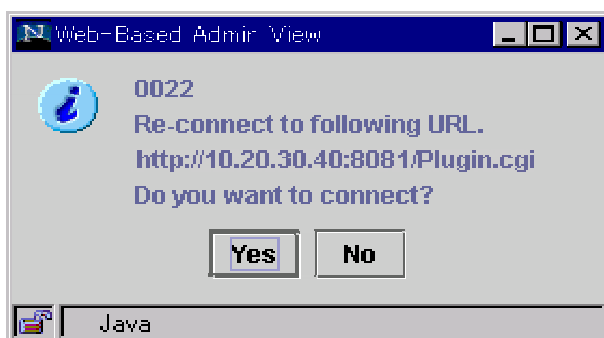

In this case, follow the instructions below:

- 1) If another application has already been activated  
After exiting all active applications, specify the URL specified by the message and re-access it.
- 2) If no other application has been activated  
Start up the application in response to the message dialog.  
In this case, be careful to ensure that the displayed URL is automatically connected after the top menu of the current Web-Based Admin View is terminated.  
When you wish to redisplay the top menu of the Web-Based Admin View that was displayed first, start up the new window of the Web browser or other new Web browser and perform access using the first access method (`http://<host name>` or `<IP address>:<port number>`).

- The following message may be output when a menu is selected during other menu is activating.

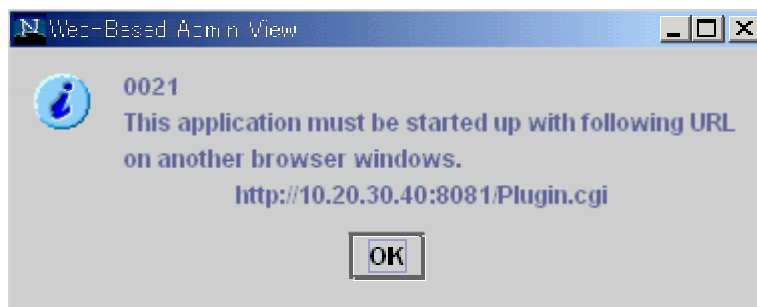

In this case, create new windows of the browser, specified the URL specified by the message, or re-select the menu after exiting all active application.

### 3.3.2 Common Menu Facilities

The Common menu supports the following facilities.

[Common menu outline] provides an outline of menu facilities and manual reference locations.

Click the arrow button close to the [Common] menu button to return to the top menu.

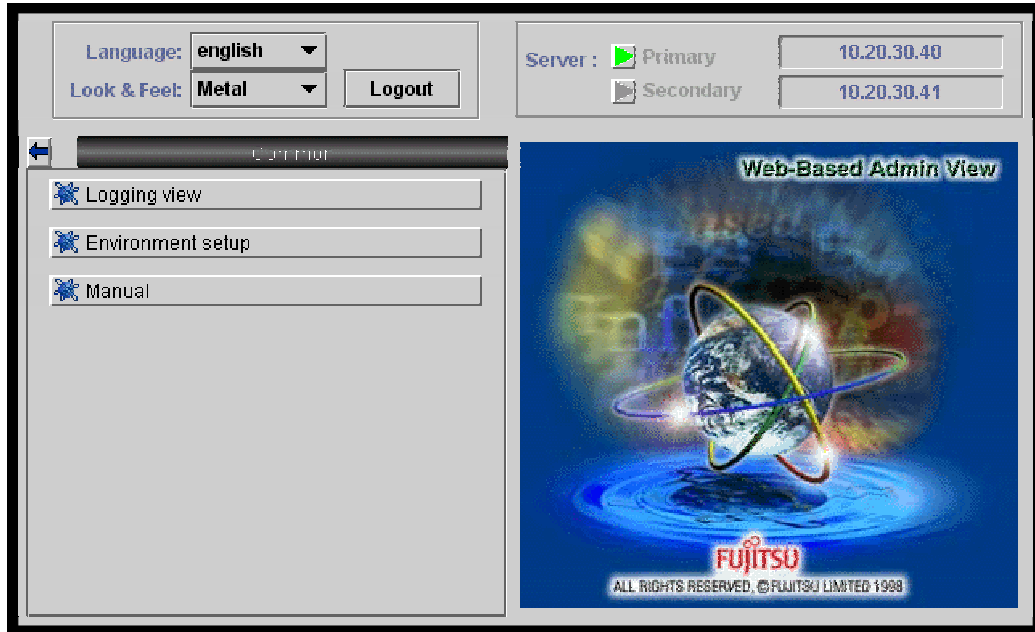

Common menu outline

- **Logging View**

Outline: Displays the certification log and operation log files that are collected with the Web-Based Admin View. For reference, the retrieve facility can be used to fetch information.

Reference location: Chapter 5 "Web-Based Admin View log reference"

- **Environment Setup**

Outline: You can set up the environment of the Web-Based Admin View.

The operation environment of the Web-Based Admin View includes three types, that is, the user environment, system environment, and node environment.

Reference location: Chapter 4 "Environment setup"

- **Manual**

Outline: Indicates the manual.



**Note**

Note that the online manual installed or uninstalled after the Web-Based Admin View is started cannot be displayed unless the Web-Based Admin View is restarted.

### 3.3.3 Using Operation Management Products with Different Access Methods Simultaneously

Each operation management product provided on Web-Based Admin View may have a different access method to the management server as described in 3.2 “Starting the Web-Based Admin View Menu.”

To use operation management products with different access methods simultaneously, start up two Web browsers or start up a new window from the Web browser. Then, specify a URL according to the specified access method on each different browser screen and display the top menu of the Web-Based Admin View.



**Note**

In case of using a **non-Java** Plug-in access method:

- **Use Netscape Communicator** since Internet Explorer is not available.
- When starting a menu of the operation management product supporting Java Plug-in within the Web-Based Admin View screen, the automatic connection is created by a Java Plug-in access method. In this instance, other operation management product is not activated. For details, refer to 3.3.1 “Web-Based Admin View menu facilities.”

## 3.4 Exiting from the Web-Based Admin View Menu

Exit from the top menu of the Web-Based Admin View as described below:

### ◆ Logout from screen

Take the following steps to log off the top menu of the Web-Based Admin View;

1. Close all screens if the management window of the operation management product is displayed.
2. Select [Logout] only when the top menu of the Web-Based Admin View is displayed.

### ◆ Exit of screen

Take the following steps to exit the top menu of the Web-Based Admin View;

1. Log off the top menu of the Web-Based Admin View according to above “Logout from screen.”
2. The login screen is displayed. To close the login screen and then exit the top menu of the Web-Based Admin View.
  - Exit the web browser.
  - The screen is automatically switched by specifying a new URL or other book mark.
  - Click [Back] of the web browser.



#### Note

- When exiting the web browser, select the [File]-[Close] menu, or click the [X] button on upper-right corner of browser.  
Note in the case of using Netscape that all web browsers are exited when the [File]-[Exit] menu is selected.
- The login screen cannot be closed by clicking the [X] button of upper-right corner in the screen.
- The login screen might remain in a while after exiting the web browser.

## 3.5 Operating the Web-Based Admin View Screens

The following explains the operation of the mouse and others with the Web-Based Admin View.

### 3.5.1 Tentative modification of screen display settings (Language, Look & Feel)

If necessary, Look & Feel of the screen can be changed from Web-Based Admin View.

#### ■ Changing the language and Look & Feel

To change language and Look & Feel setting, select [Language] and [Look & Feel] in the Web-Based Admin View screen. The display setup on the screen is only a tentative change; the style modification is effective only in the active browser. So, if the Web-Based Admin View screen or other browser is activated, you need to set up again.



#### Information

In order to save the screen display settings, select [Common]-[Environment setup] menu, and then set up [System environment]-[Display setting].  
For details, refer to Chapter 4 "Environment setup."

The setup of screen Language and Look & Feel is described below.

Language:	english ▼	Logout
Look & Feel:	Metal ▼	

#### Language

Select [japanese] or [english]. Note it is not available when other menu is working.

#### Look & Feel

Specify the screen style.

For the Look & Feel screen, there are following three types: Users can select any type.

- Metal
- CDE/Motif
- Windows (Valid only for Windows(R) 95, Windows(R) 98, Windows(R) 98 Second Edition, Windows(R) Me, Windows(R) 2000, Windows NT(R)4.0)



#### Note

Language support varies depending on the operation management product to be installed.  
For details, refer to the documentation of each operation management product.

## 3.5.2 Switching the Management Server to Be Connected

At the Web-Based Admin View, you can switch the management server to be connected, if necessary.

### ■ Switching the management server

To switch the management server, click the management server switching buttons at the top right of the top menu.

The switching buttons display the IP addresses of the currently active primary management server and secondary management server. The management server displayed with the green mark is the management server that the client is currently connected to.

To switch the management server, log off, then select the management server button that is not displayed with a green mark.



Note

The management server switching buttons are enabled only when you are logged off.

## 3.5.3 Changing the Screen Size

Note the following when changing the screen size:



Note

A change of the screen size is temporary. The information describing the screen size is not retained when the browser is terminated.

When the screen size is changed, logout can occur automatically depending on the browser.

## 3.5.4 Using the Mouse

Use the mouse to make the following selections:

### Single selection

To select an item such as an icon, button, or menu, position the mouse pointer to the desired item. Then, left-click to select the target of operation. If single selection is repeated, the last item selected will be enabled.

### Multiple selection

While holding down the [Shift] key, position the mouse pointer on an item and click the mouse button.

### Canceling selection

While holding down the [Ctrl] key, position the mouse pointer on the item to be canceled and click the mouse button.

### Deselecting text

Position the mouse pointer on an area other than icons or selection items and click the mouse button to cancel all selections.



## 3.6 Stopping Web-Based Admin View

The Web-Based Admin View that is used to display the Web-based Admin View for the client is automatically started on the management server or management node when the system starts. No special operation is required to start or stop it. If Web-Based Admin View must be stopped because, for example, the management server or monitoring node settings were changed, perform the following operations with system administrator authority.

◆ **Operation:**

1. # `/etc/init.d/fjswvcnf stop`
2. # `/etc/init.d/fjswvbs stop`



**Note**

- Be aware the Web-Based Admin View screen on the client is closed when stopping the operation. If the service stops while the Web-Based Admin View screen is active, the following message might be displayed: "0007 Management server session disconnected. Do you want to try to re-connect working Management Server ?"
- In a two-layer model that is used both as a management server and a monitoring node, the Web-Based Admin View on the monitoring node is stopped.
- If the Web-Based Admin View cannot be stopped for some reason, use the command described in 3.7 "Restart Web-Based Admin View" to restart it. After restart, terminate the operation again.

## 3.7 Restart Web-Based Admin View

The Web-Based Admin View that is used to display the Web-based Admin View for the client is automatically started on the management server or management node when the system starts. No special operation is required to start it.

If you must restart Web-Based Admin View because, for example, you have changed the management server or monitoring node settings, execute two commands with system administrator authority as shown in the procedure below.

◆ **Operation:**

1. # `/etc/opt/FJSVwvbs/etc/bin/wvCntl restart`
2. # `/etc/init.d/fjsvwvcnf restart`



**Note**

- Be aware that the Web-Based Admin View screen is closed on all clients when restarting. If you change the settings while the Web-Based Admin View screen is active, the following message might be displayed: "0007 Management server session disconnected. Do you want to try to re-connect working Management Server ?"
- In a two-layer model that is used both as a management server and a monitoring node, the Web-Based Admin View in the monitoring node is restarted.
- Restart Web-Admin View after you perform the following operations.
  - Modification of the http port number or RMI port number
  - Modification of the management server
  - Modification of the Java environment
  - Modification of the IP address used by a public LAN
  - Modification of environment variable by executing a command
  - Modification of the secondary management server automatic migration
  - Modification of the connections to an active management server

## 3.8 Setting Operating Conditions for Web-Based Admin View

To set whether Web-Based Admin View is to be started automatically when the system is started, execute the following command or commands in the node to be set.

Be sure to apply this setup as long as any operation management view (GUI) is not used.

**[Settings disabling WWW Server for Admin View and Web-Based Admin View]**

```
# /etc/opt/FJSVwvbs/etc/bin/wvrscript uninstall
```

**[Settings needed to launch WWW Server for Admin View and Web-Based Admin View automatically at system startup]**

```
# /etc/opt/FJSVwvbs/etc/bin/wvrscript install
```

Either the **WWW Server for Admin View** or **Web-Based Admin View** can be used for making the specification, as follows:

- To start Web-Based Admin View automatically when the system is started  
# /etc/opt/FJSVwvbs/etc/bin/wvrscript install FJSVwvcnf
- To not start Web-Based Admin View when the system is started  
# /etc/opt/FJSVwvbs/etc/bin/wvrscript uninstall FJSVwvcnf
- To automatically start Web-Based Admin View  
# /etc/opt/FJSVwvbs/etc/bin/wvrscript install FJSVwvcnf
- To prevent the use of the WWW server function when the system is started  
# /etc/opt/FJSVwvbs/etc/bin/wvrscript uninstall FJSVwvcnf

Note that, if you use this setting, neither machine management nor the management view provided by SynfinityCluster will be unusable.



## **Part 3      Common Menu**

---

---

This section outlines the functions provided by the Common menu.



# Chapter 4 Environment setup

---

## Target users

All users of the Web-Based Admin View

Set the operation environment for the Web-Based Admin View as described below.



**Point**

For reference or setup of operation environment, there are two methods; one is execute a command directly on each management server and monitoring node, and the other is on an environment setup screen. The latter one is explained below.

Normally, when the setup is modified on the environment setup screen, all monitoring nodes should be activated, and are connected to the primary management server as well. If there's an inactive monitoring node or non-monitored node by the primary management server, refer to 4.5 "Reference and modification by command" and set up as required on each node.

There are following three kinds of functions with the environment setup screen. Each screen is displayed by selecting a tab.

- User environment
- System environment
- Node environment

The following usage varies according to each function;

	User environment	System environment	Node environment
<b>Use</b>	Set tentative operating conditions	Determine the operating conditions of the entire system	Specific setting for each monitoring node
<b>Target user</b>	All users	The root user or the user that belongs to the Web-Based Admin View administrator group (wvroot) [*1]	
<b>Setup timing</b>	As long as the Web-Based Admin View is active.		
<b>Setup validation timing [*2]</b>	[End] -> 0052 message : select [Yes] -> the value is validated right.	[End] -> 0051 message : select [Yes] -> 0015 message : select [OK] -> Log off [*3] -> { Web-Based Admin View running on the management server restarts automatically } -> 0003 message : the value is validated.	[End] -> 0059 message : select [Yes] -> 0015 message : select [OK] -> Log off [*3] -> { Web-Based Admin View running on the management server restarts automatically } -> 0003 message : the value is validated.

[\*1] The user who login by authority of another user group, except administrator group (wvroot), cannot set the system environment and the node environment because the tabs for those environments are not displayed.

[\*2] Explain the operation procedure from selecting [End] in the environment setup screen to validating of setting value.

00xx : Indicates the number of a displayed message.

[\*3] Be sure to log off all clients connecting to the management server. Web-Based Admin View waits for the timing when all clients are logged off, and then restarts automatically. When selecting [Yes] to 0051 or 0059 message, 0015 message is displayed on all clients. Be sure to log off all clients.

When any client is logged in, Web-Based Admin View is started up again automatically if some time (10 minutes) passes. So the logged-in clients must be logged off, and then 0007 message is displayed.



## 4.1 Environment setup start

Start the environment setup as described below.

**Target users:** All users of Web-Based Admin View.

- Select the [Common] button on the Web-Based Admin View menu.

### Web-Based Admin View menu

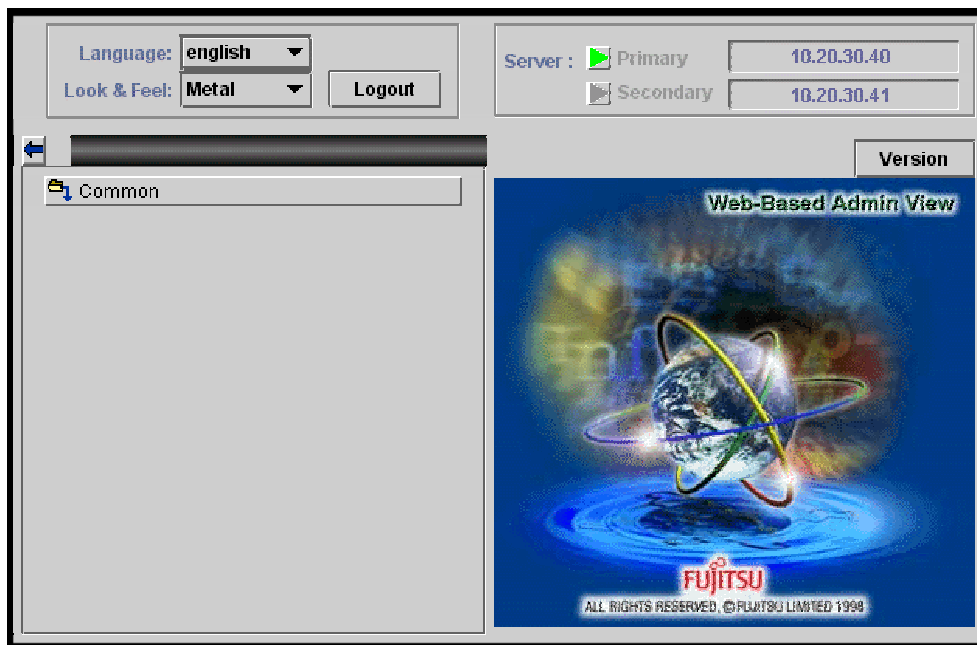

- Select the [Environment setup] button in the [Common] operation menu.

### Common operation menu

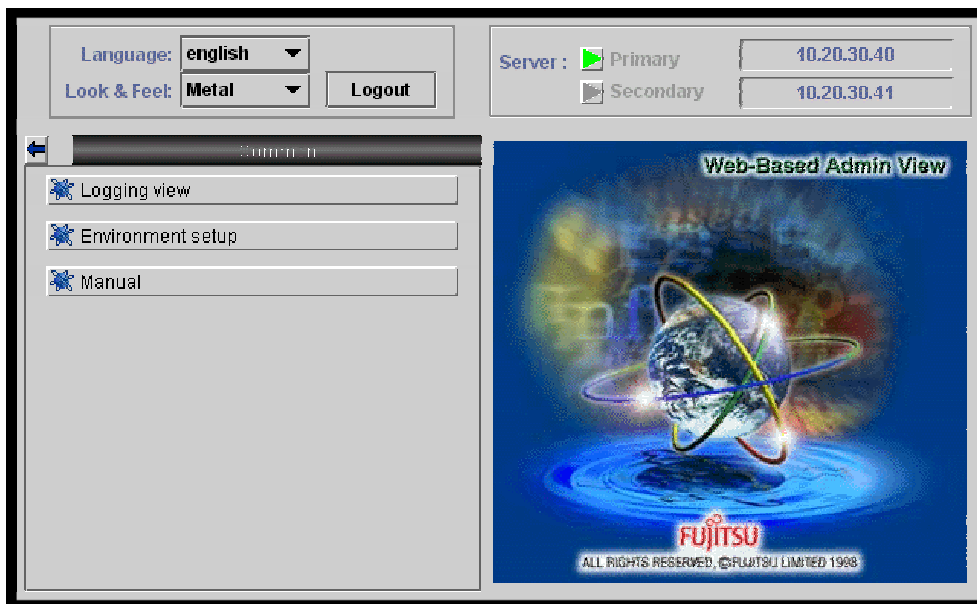

The Environment setup screen is displayed.

## 4.2 User environment

### Target users

All users of the Web-Based Admin View menu

### Notices on user environment setup

- Client detailed trace log  
Select this item when specific client information is necessary for maintenance or troubleshooting.  
The initial value is "No."
- Inactivity timeout  
The inactivity timeout is a security feature which locks Web-Based Admin View after a fixed period, so an unauthorized user cannot perform arbitrary operations when an authorized user is away from his seat.  
The initial value is "No."
- Inactivity timeout interval  
The inactivity timeout interval is standby time until Web-Based Admin View is locked.  
The initial value is "10 minutes."



#### Note

Note that the user environment setup only remains valid until logout. The value is default system setting at the next login.

## 4.2.1 Log & Inactivity timeout

Set the client detailed trace log, inactivity timeout, and the inactivity timeout interval as described below.

### User environment (Log & Inactivity timeout) screen

#### Client detailed trace log

Specify whether to collect a detailed trace.

#### Inactivity timeout

Specifies whether the inactivity timeout is used. Specifying [Yes] enables the timeout, and [No] disables it.

#### Inactivity timeout interval

The inactivity timeout interval is displayed only if the inactivity timeout is enabled. The inactivity timeout interval may be set using the slider bar. You may also enter the time directly and press [Enter]. The timer units are in minutes, and any number from 10 to 60 may be entered.



#### Information

#### On the inactivity timeout

The inactivity timeout is a security feature. If the user does not interact with GUI at the specified interval, GUI will force the user to re-enter his password before any further operations are allowed. After the password is successfully entered, the user can continue working.



**Note**

Support of varies depending on the operation management product. For details, refer to the documentation provided with each management product.

## 4.3 System environment

### Target users

Users who belong to the Web-Based Admin View administrator group



#### Note

- After all of the operation management view are exited, use the environment setup menu.
- The system environment is available only when the environment setup is activated in the primary management server.

### ■ Notices on system environment setup

The followings explain setting items and conditions where they are required:

#### System environment setup item list

Item		Initial value	Use
Display setting	Language	Automatic setting by OS locale environment	Use this item to change the language or the Look & Feel displayed on the screen.
	Look & Feel	Metal	
Client detailed trace log		No	The trace log should be set up when the specific client information is required for maintenance and troubleshooting.
Inactivity timeout	Inactivity timeout	No	This blocks improper operations by the unauthorized users by locking Web-Based Admin View. This function's validation varies depending on each operation management product.
	Inactivity timeout interval	10 minutes	
Primary management server		default set at installation	To change the IP address of the primary management server.
Secondary management server		default set at installation	To change the IP address of the secondary management server
Secondary management server automatic migration		No	Execute the 6.4 "Changing the secondary management server automatic migration" setting.
Client – management server connection time		10 seconds	Specify the time interval of the client to monitor the management server. The client checks the state of the management server periodically at the specified time interval. If it takes time to connect to the client because of a network failure, enter a larger value. Then the disconnection might be avoided.
Automatic connection to management server		No	It indicates whether or not the client be connected automatically to an active management server. The displayed value cannot be modified on the GUI screen. Note that this parameter is invalid in this version.
Management server - monitoring node connection time		10 seconds	It specifies the time interval of the management server surveillance for the monitoring node. The management server monitors requests from a monitoring node at regular intervals. If it takes time to connect to the client because of a network failure, enter a larger value. Then the disconnection might be avoided.

Item	Initial value	Use
Reconnection interval	30 seconds	It determines the interval of connection requests issued from the monitoring node to the management server.
Number of stacked events	100	The valid parameter (e.g. SynfinityCluster) only when a product implementing event notification from a monitoring node is installed. Specify the number of log events reported from the monitoring node that should be held in the management server. If the management server is switched because of a failure, this temporary held events is used to distinguish the events that are properly handled in the management server before failure, and the events that should be taken action in the new management server. Normally, this item does not have to be changed. However, if event failure occurs during the switchover of management server, input larger value. This might avoid disconnection.

**Log files / Trace log files**

To set up these items when specific information is required for maintenance and troubleshooting.

Normally, setup modification is not required.

Item	Initial Value	
Login log	File size	100K
	Number of files	2
Operation log	File size	100K
	Number of files	5
Event log	File size	100K
	Number of files	2
Management server trace log	File size	200
	Number of files	5
	Detailed trace log	Yes
Monitoring node trace log	File size	200
	Number of files	5
	Detailed trace log	Yes



**Note**

When the system environment setup is modified, the Web-Based Admin View is restarted to make it valid.

### 4.3.1 Display setup

Set the display language and Look & Feel.

#### System environment (Display setting) screen

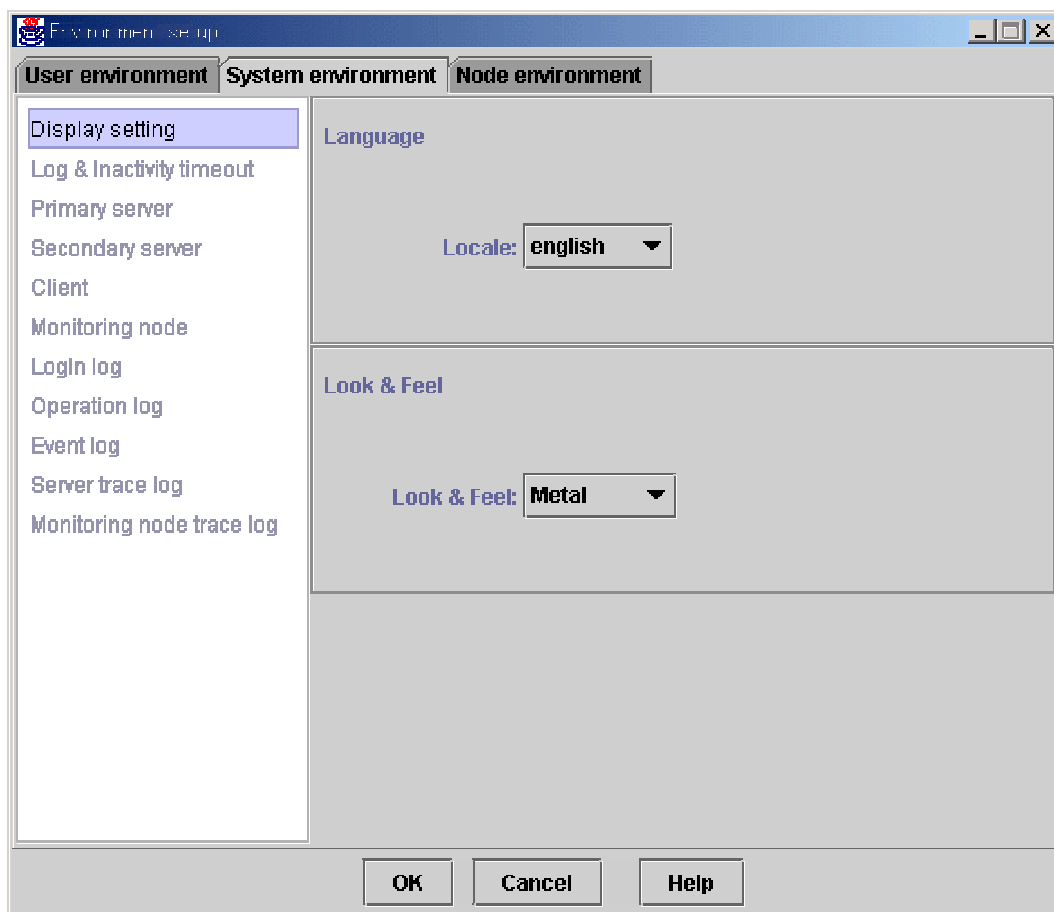

#### Language

Set "japanese" or "english" to be displayed on the screen.

#### Look & Feel

Select Metal (default), CDE/Motif, or Windows for the screen look and feel.



#### Point for Language

- **The initial value of Language after installation**

The initial value of Language is determined by the LANG environment variable in the file ( /etc/init/default ) on the management server.

If each locale varies depending on two or more hosts (nodes), the locale of the primary management server is set up at initial operation of Web-Based Admin View after startup.

Condition		Initial value
LANG=	character string beginning with "ja"	japanese
	others	english

- **Setting value (Recommended value)**

Since the setting value of Language is used for the displaying locale on client and the operating locale of Web-Based Admin View, verify the operating environment of the client

and the management server and set the proper locale. Recommended value is following.  
 The recommended value is described below.

		OS environment of management server (Locale at startup)	
		"ja" or "japanese"	others
<b>Operating OS on PC client</b>	non-Japanese OS	english	english
	Japanese OS	japanese	english
<b>Installed OS on Solaris Workstation</b>	Japanese package is installed.	japanese	english
	Japanese package is not installed.	english	english



**Note**

- The Language support varies depending on each operation management product. For details, refer to the manual of each management product.



## 4.3.2 Log & Inactivity timeout

Set up the client detailed trace log, inactivity timeout, and the inactivity timeout interval as described below.

### System environment (Log & Inactivity timeout) screen

#### Client detailed trace log

Specify whether to collect a detailed trace.

#### Inactivity timeout

Specifies whether the inactivity timeout is used. [Yes] enables this function, and [No] disables it.

#### Inactivity timeout interval

The inactivity timeout interval can be set using the slider bar. You may also enter the time in the text field and press [Enter]. The timer units are indicated in minute. Enter any number from 10 to 60.

The inactivity timeout interval is displayed only if it is enabled.



#### Information

#### On the inactivity timeout

The inactivity timeout is a security feature. If the user does not interact with GUI at the specified interval, GUI will force the user to re-enter his password before any further operations are allowed. After the password is successfully entered, the user can continue working.



**Note**

Support varies depending on the operation management product. For details, refer to the manual of each product.

### 4.3.3 Primary management server

Set the IP address of the primary management server.

#### System environment (Primary server) screen

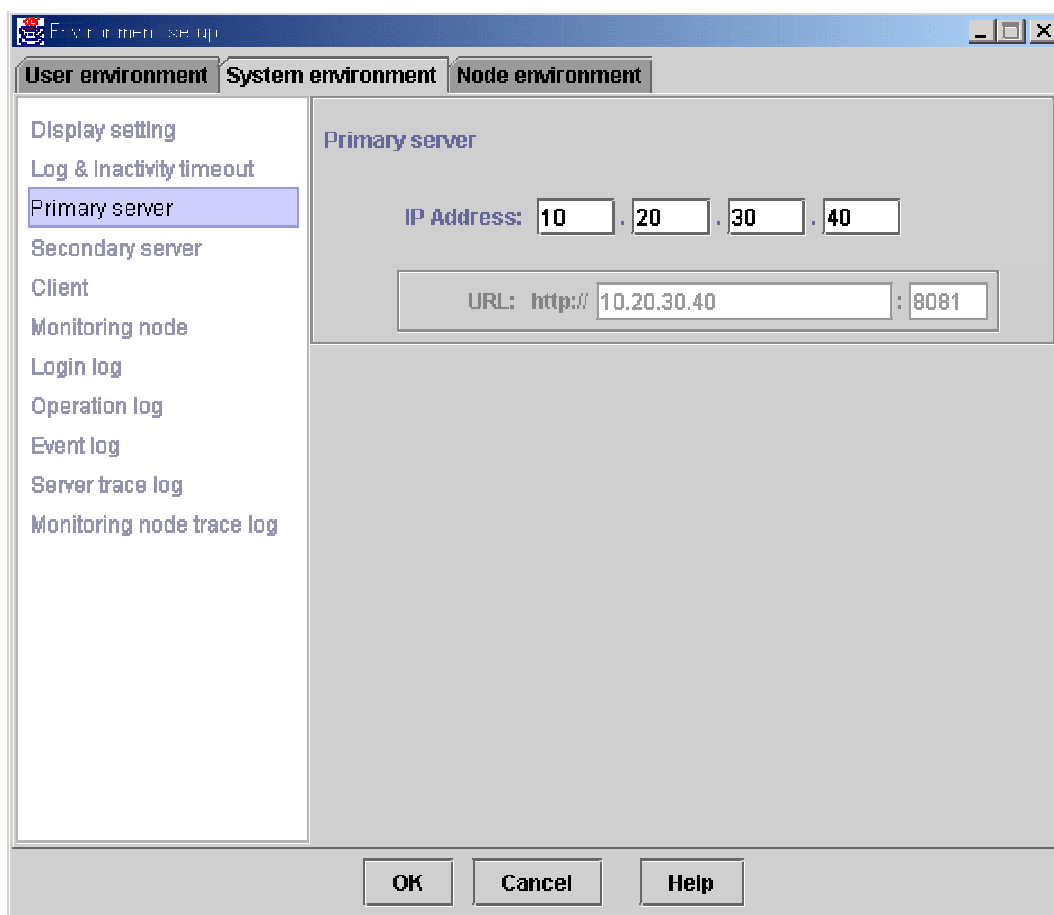

#### Primary server

Enter the IP address of the primary management server. For example, enter "10," "20," "30," "40" for the IP address "10.20.30.40".

The displayed URL cannot be modified. Also, the current URL of the primary management server is displayed.

#### 4.3.4 Secondary management server

Set the IP address of the secondary management server.

**System environment screen (when the secondary management server automatic migration is selected)**

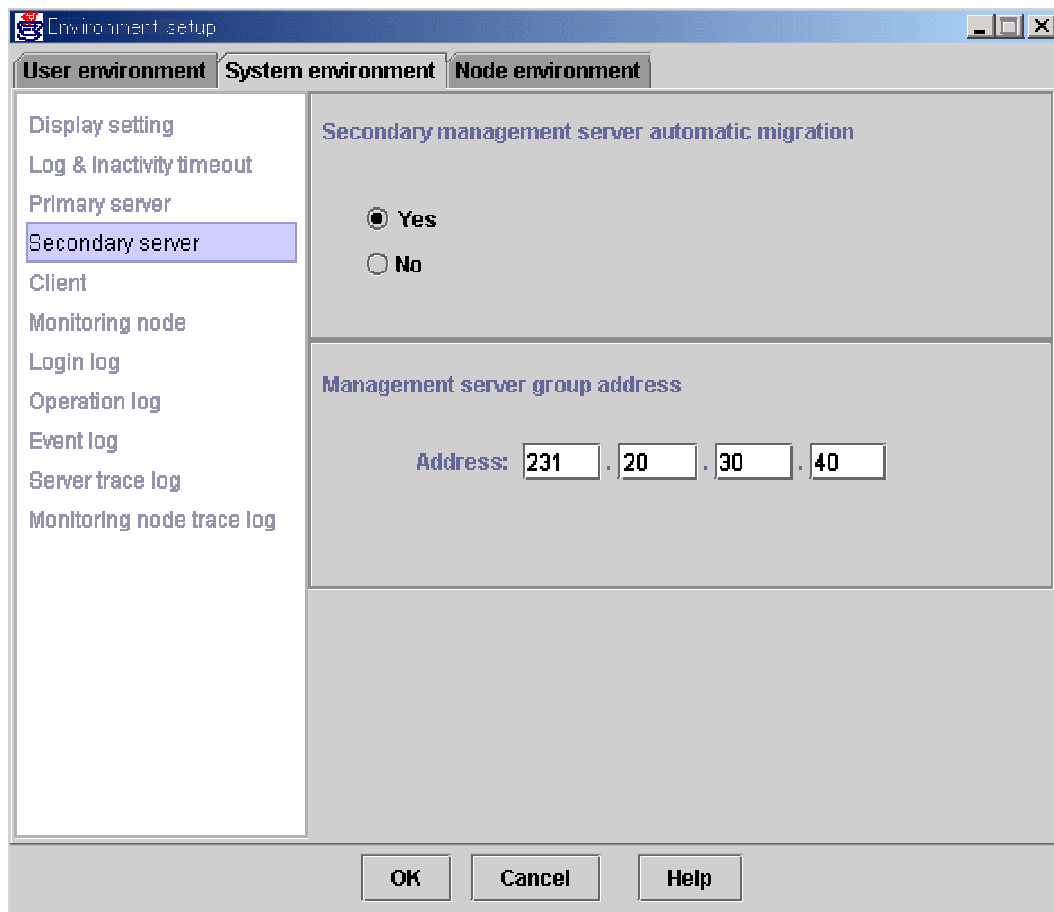

### System environment screen (when the secondary management server automatic migration is not selected)

The screenshot shows a window titled "Environment setup" with three tabs: "User environment", "System environment", and "Node environment". The "System environment" tab is active. On the left is a list of settings: Display setting, Log & Inactivity timeout, Primary server, Secondary server (highlighted), Client, Monitoring node, Login log, Operation log, Event log, Server trace log, and Monitoring node trace log. The main area is divided into two sections. The top section, "Secondary management server automatic migration", contains two radio buttons: "Yes" (unselected) and "No" (selected). The bottom section, "Secondary server", contains an "IP Address:" label followed by four input fields with values "10", "20", "30", and "40". Below this is a "URL:" label followed by a text box containing "http://10.20.30.40" and a port field containing "8081". At the bottom of the dialog are "OK", "Cancel", and "Help" buttons.

#### Secondary management server automatic migration

Specify whether or not the secondary management server automatic migration is selected. When "Yes" is selected, the [Management server group address] setting is available. When "No" is selected, the [Secondary management server] setting is available.

#### Management server group address

Set the **Multicast address** or broadcast address including the potential management server that is automatically selected from the secondary management server.

#### Secondary server

Enter the IP address of the secondary management server. For example, enter "10," "20," "30," "40" for the IP address "10.20.30.40". The URL of the secondary management server that is currently set is displayed.



#### Note

Whenever possible, set a multicast address for the management server group address. If the IP address of the primary management server is "10.20.30.40," change "10" to "231" to make the management server group address to "231.20.30.40."

### 4.3.5 Client

Set the connection monitoring time between the client server and the management server, and display the automatic connection to the management server.

#### Screen environment (Client) screen

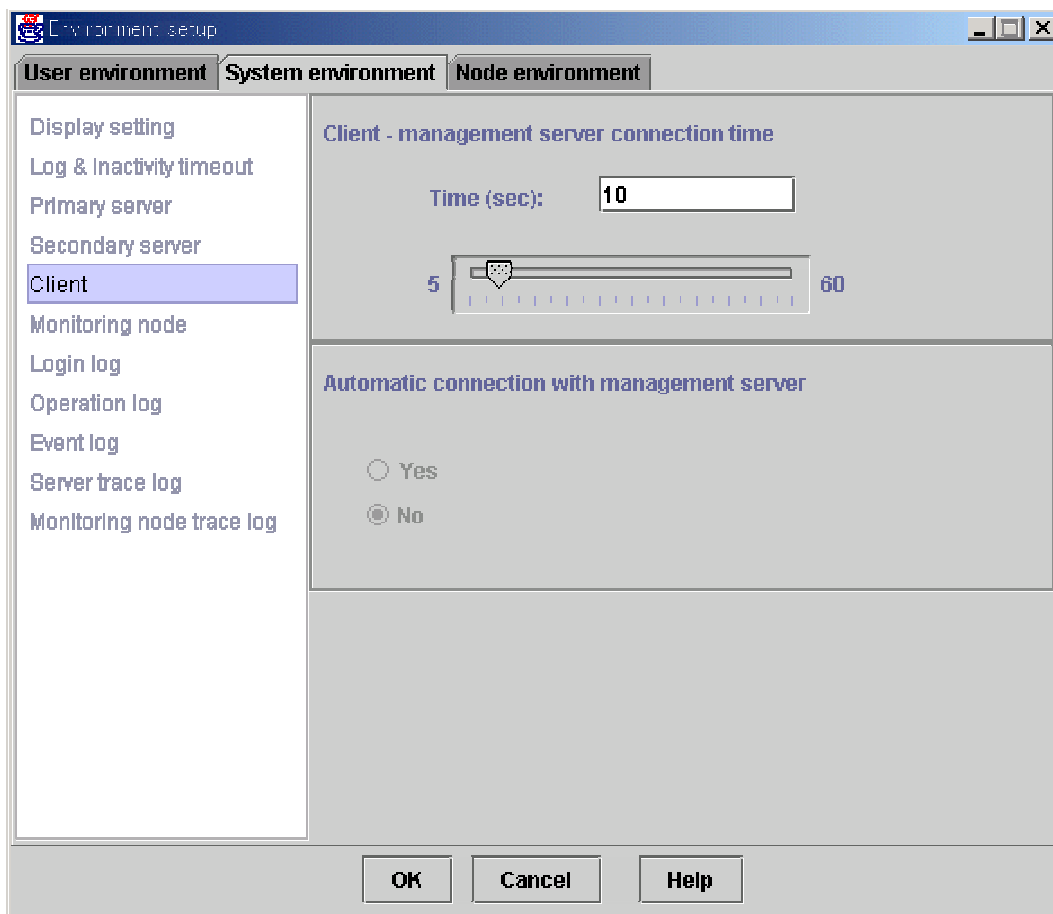

#### Client – management server connection time

Enter the interval (from 5 to 60 seconds) in the text field and press [Enter], or set the interval by moving the bar (slider) to the left or right.

#### Automatic connection with management server

This parameter is invalid in this version.

### 4.3.6 Monitoring node

Set the connection monitoring time between the monitoring node and the management server, the reconnection interval, and the number of events stacked as described below.

#### System environment (Monitoring node) screen

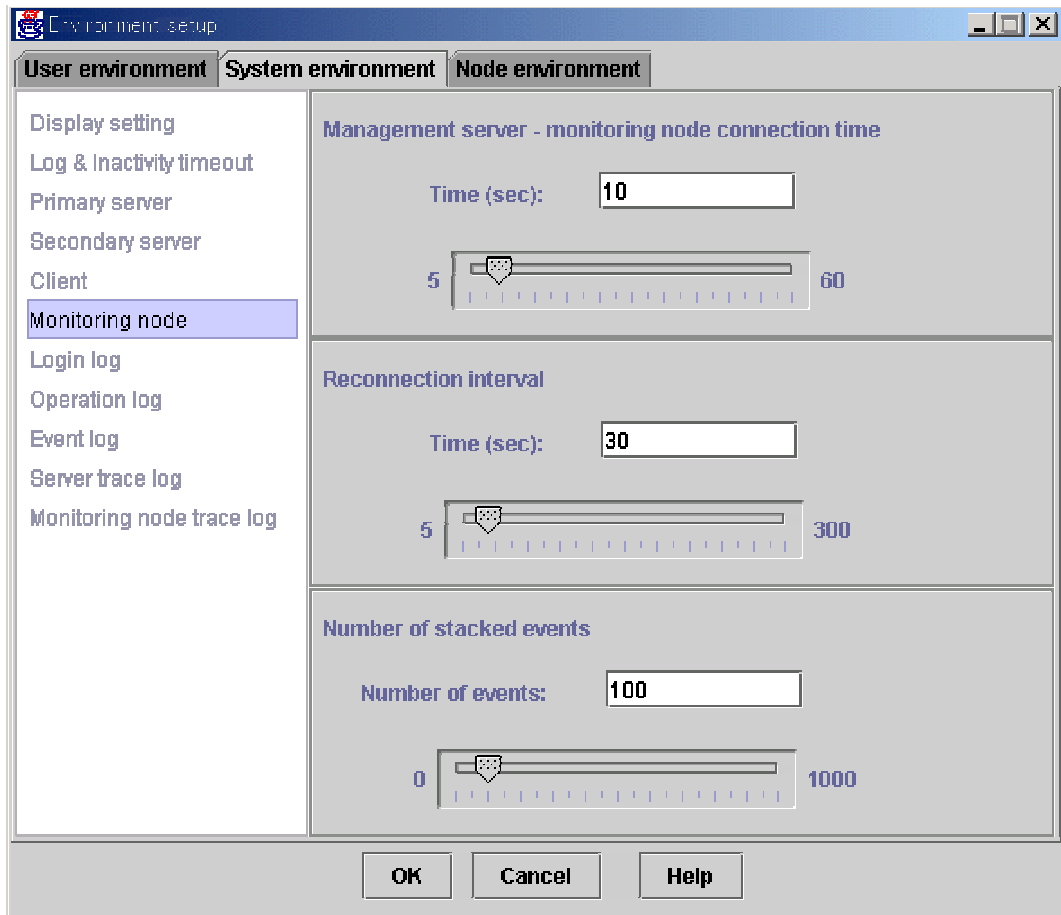

#### Management server - monitoring node connection time

Enter the interval (from 5 to 60 seconds) in the text field and press [Enter], or set the interval by moving the bar (slider) to the left or right.

#### Reconnection interval

Enter the interval (from 5 to 300 seconds) in the text field and press [Enter], or set the interval by moving the bar (slider) to the left or right.

#### Number of stacked events

In the text field, enter the number of events (from 0 to 1000) and press [Enter] to be stacked in the monitoring node in case of a management server communication failure, or set the number by moving the bar (slider) to the left or right.

### 4.3.7 Login log

Set the size and number of login log files for the management server as described below.

#### System environment (Login log) screen

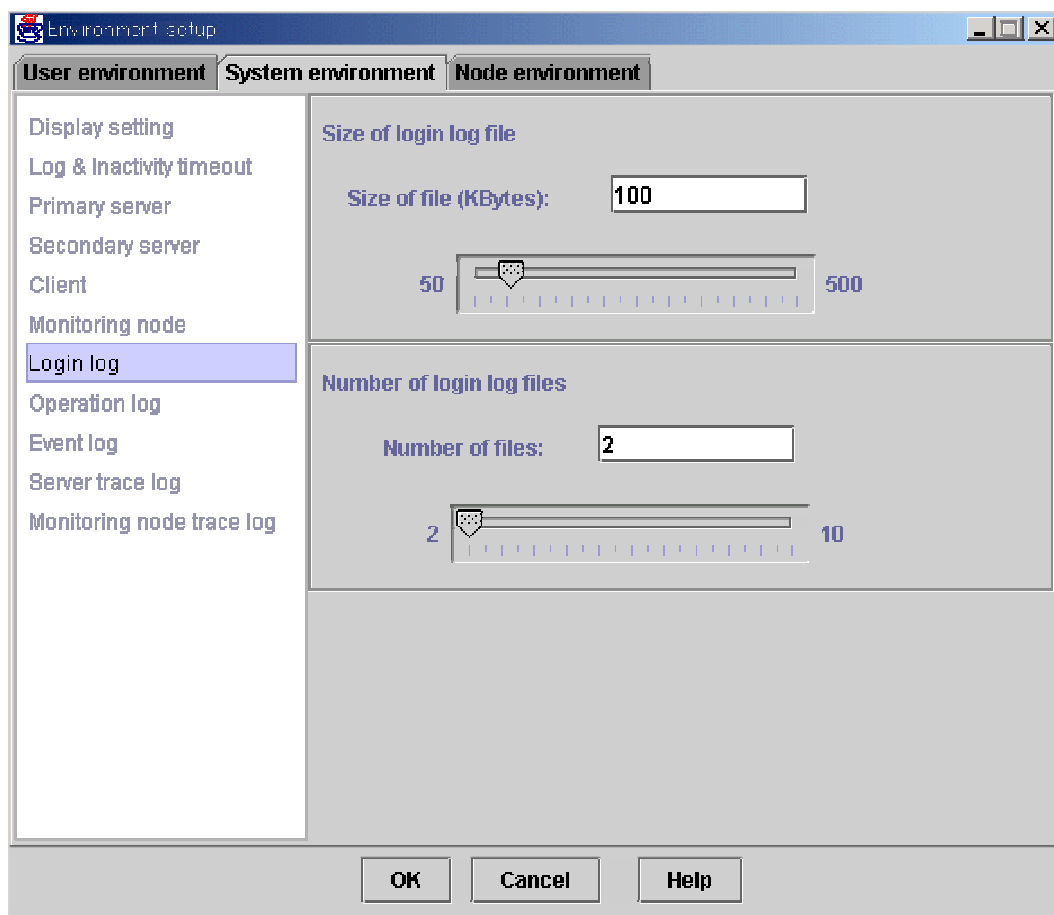

#### Size of login log file

Enter the file size (from 50 to 500 KB) in the text field and press [Enter], or set the size by moving the bar (slider) to the left or right.

#### Number of login log files

Enter the number of files (from 2 to 10) in the text field and press [Enter], or set the number by moving the bar (slider) to the left or right.

### 4.3.8 Operation log

Set the size and number of operation log files for the management server as described below.

#### System environment (Operation log) screen

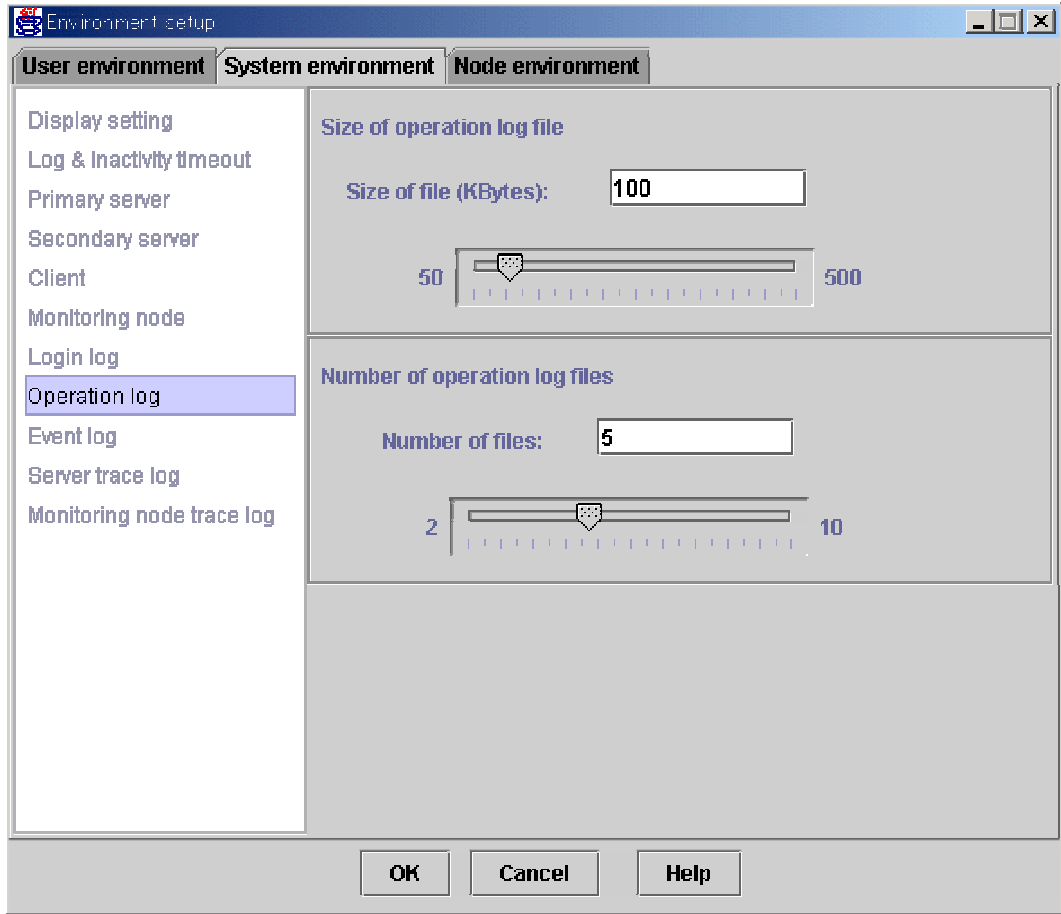

#### Size of operation log file

Enter the file size (from 50 to 500 KB) in the text field and press [Enter], or set the size by moving the bar (slider) to the left or right.

#### Number of operation log files

Enter the number of files (from 2 to 10) in the text field and press [Enter], or set the number by moving the bar (slider) to the left or right.



### 4.3.9 Event log

The following parameters are valid only if the operation management products like SynfinityCluster supporting event notification from a monitoring node are installed.

The size and number of event log files to be stacked in the management server are set up.

#### System environment (Event log) screen

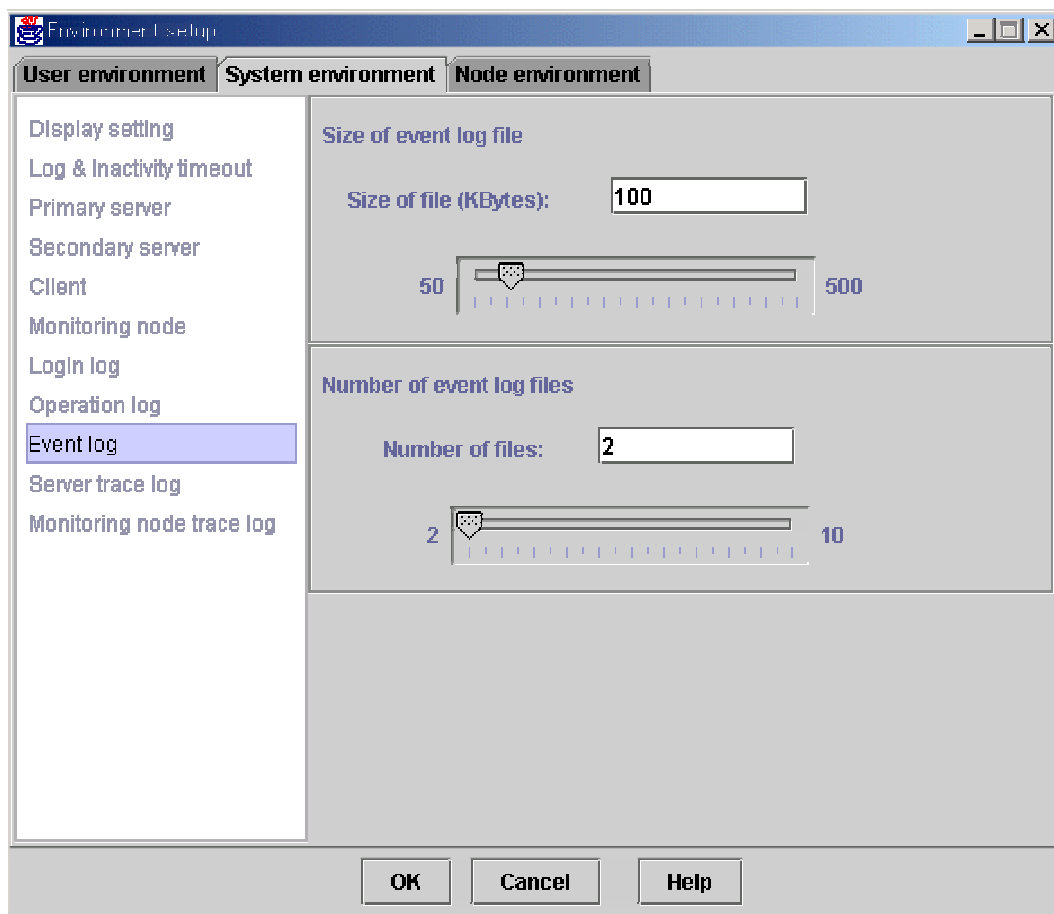

#### Size of event log file

Enter the file size (from 50 to 500 KB) in the text field and press [Enter], or set the size by moving the bar (slider) to the left or right.

#### Number of event log files

Enter the number of files (from 2 to 10) in the text field and press [Enter], or set the number by moving the bar (slider) to the left or right.

### 4.3.10 Server trace log

Set the size and number of management server trace log files, and whether to collect a management server detailed trace log as described below.

#### System environment (Server trace log) screen

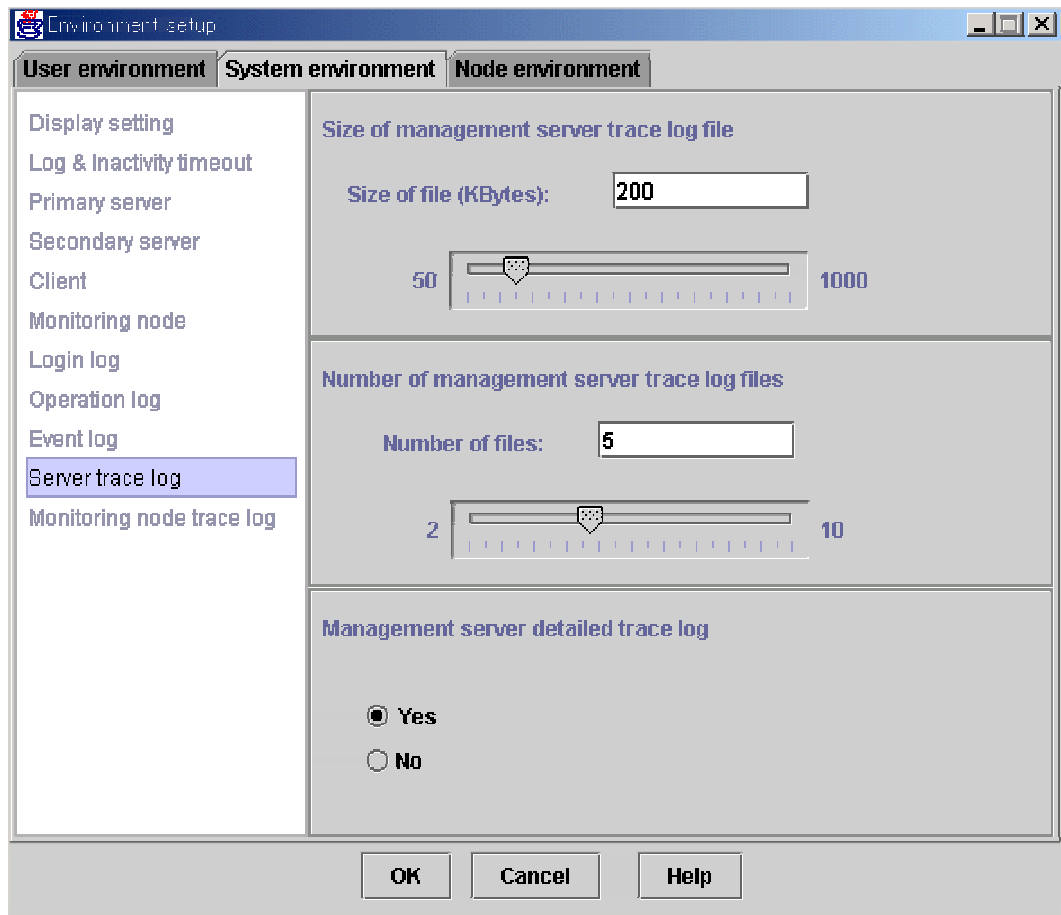

#### Size of management server trace log file

Enter the file size (from 50 to 1000 KB) in the text field and press [Enter], or set the size by moving the bar (slider) to the left or right.

#### Number of management server trace log files

Enter the number of files (from 2 to 10) in the text field and press [Enter], or set the number by moving the bar (slider) to the left or right.

#### Management server detailed trace log

Select whether to collect a management server detailed trace log.

### 4.3.11 Monitoring node trace log

Set the size and number of node trace log files, and whether to collect a node detailed trace log as described below.

#### System environment (Monitoring node trace log) screen

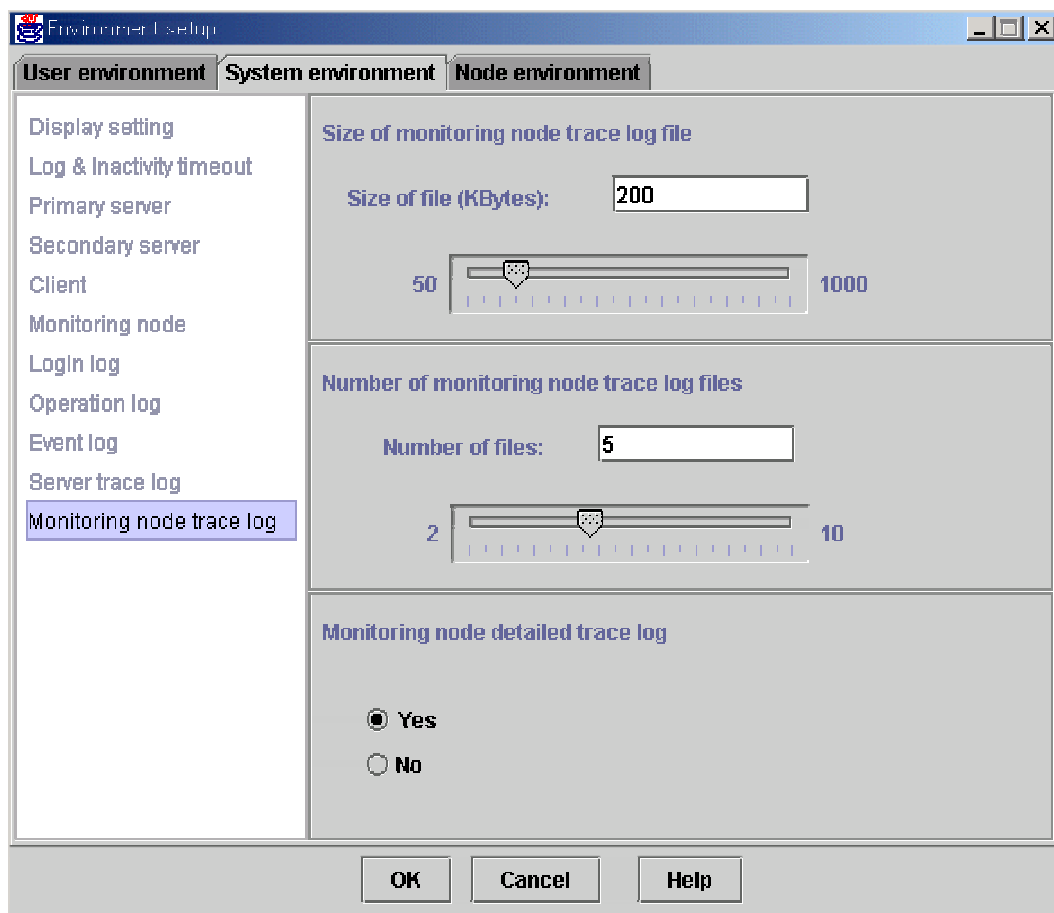

#### Size of monitoring node trace log file

Enter the file size (from 50 to 1000 KB) in the text field and press [Enter], or set the size by moving the bar (slider) to the left or right.

#### Number of monitoring node trace log files

Enter the number of files (from 2 to 10) in the text field and press [Enter], or set the number by moving the bar (slider) to the left or right.

#### Monitoring node detailed trace log

Select whether to collect a monitoring node detailed trace log.

## 4.4 Node environment

### Target users

Users who belong to the Web-Based Admin View administrator group

### List of node environment setup items

- IP address / Host name of the public LAN:  
Set up when modifying the IP address or the host name of public LAN on the management server or the monitoring node for the environment setup.
- IP address / Host name of the WWW server:  
If the monitoring node for environment setup is a management server, the IP address or the host name that is set for the clients is displayed.  
The displayed IP address / host name cannot be modified on the GUI screen. For modification, refer to 6.5 "Using the Management Server in a Split-network Environment."
- Object of secondary management server automatic migration:  
Specify whether the monitoring node is automatically selected as the secondary management server when 6.4 "Changing the secondary management server automatic migration" is set.



### Note

- From [Node], select a management server or node, and then set up respectively.
- When setting the operation environment, exit all other applications of Web-Based Admin View first.
- When the node environment setup items are modified, Web-Based Admin View of the monitoring node is restarted to enable the settings.

### 4.4.1 IP address / Host name

Set up or display the IP address and host name of the public LAN and WWW server.

#### Node environment (IP address / Host name) screen

The screenshot shows a window titled "Environment setup" with three tabs: "User environment", "System environment", and "Node environment". The "Node environment" tab is active. On the left, there is a "Node" dropdown menu showing "node1". Below it is a tree view with "IP address/Host name" selected. The main area contains two sections: "IP address / Host name of public LAN" and "IP address / Host name of WWW server". Each section has a "Name:" label and a text input field containing "10.20.30.40". At the bottom of the window are three buttons: "OK", "Cancel", and "Help".

#### IP address / Host name of public LAN

Enter the IP address of the host name used by a public LAN of the management server or monitoring node selected as [Node].

The initial value is the IP address of the public LAN.

#### IP address / Host name of WWW server

If the monitoring node selected as [Node] is used as a management server, the system displays the IP address or host name of the client.

The initial value is the IP address of the public LAN.



#### Note

If the IP address or host name of the public LAN is not designated, the environment setup cannot be terminated.

## 4.4.2 Server environment

Set whether the server should be a selection target for the secondary management server.

### Node environment(Server environment) screen

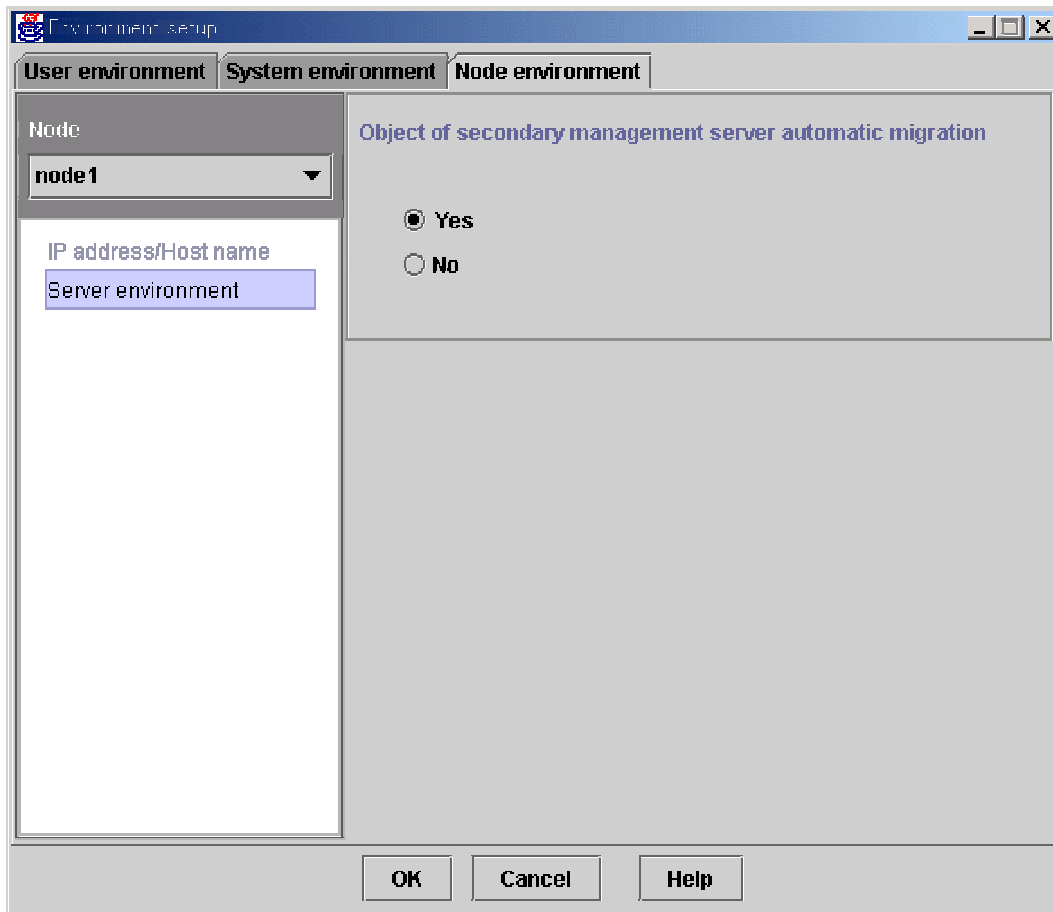

#### Object of secondary management server automatic migration

Specify whether the monitoring node selected as [Node] is to be automatically singled out as the secondary management server. The initial value is "Yes."

## 4.5 Reference and modification by command

The Web-Based Admin View administers setting items as environment variables.

These environment variables can be referred or modified by executing a command on a management server and monitoring node as well as on the Environment setup screen.

### 4.5.1 Environment variable

Web-Based Admin View internally administers is corresponding to which parameter that can be referred and modified on the Environment setup screen.

Operation environment variable list

Attribute	Environment variable	Setting value		Description
usr	look-and-feel	Metal, CDE/Motif, Windows		Look & Feel
usr	locale	Japanese, english		Language
usr	c-tlog-debug	on, off		Client detailed trace log
sys	out-time	<i>nnnn</i> (Min: 0)	minute	Inactivity timeout interval
sys	primary-server	<i>nnn.nnn.nnn.nnn</i>		IP address of Primary server
sys	secondary-server	<i>nnn.nnn.nnn.nnn</i>		IP address of Secondary server
sys	keep-time	<i>nnnn</i> (min: 5)	second	Client - management server connection time
sys	health-time	<i>nnnn</i> (min: 5, max: 60)	second	Management server - monitoring node connection time
sys	retry-time	<i>nnnn</i> (min: 5, max: 300)	second	Reconnection interval
sys	n-pending-events	<i>nnnn</i> (min: 0, max: 1000)		Number of stacked events
sys	s-llog-vol	<i>nnnn</i> (min: 50, max: 500)	kilobyte	Size of login log file
sys	s-llog-num	<i>nnnn</i> (min: 2, max: 10)		Number of login log files
sys	s-olog-vol	<i>nnnn</i> (min: 50, max: 500)	kilobyte	Size of operation log file
sys	s-olog-num	<i>nnnn</i> (min: 2, max: 10)		Number of operation log files
sys	s-elog-vol	<i>nnnn</i> (min: 50, max: 500)	kilobyte	Size of event log file
sys	s-elog-num	<i>nnnn</i> (min: 2, max: 10)		Number of event log files
sys	s-tlog-vol	<i>nnnn</i> (min: 50, max: 500)	kilobyte	Size of management server trace log file
sys	s-tlog-num	<i>nnnn</i> (min: 2, max: 10)		Number of management server trace log files
sys	s-tlog-debug	on, off		Management server detailed trace log
sys	n-tlog-vol	<i>nnnn</i> (min: 50, max: 500)	kilobyte	Size of monitoring node trace log file
sys	n-tlog-num	<i>nnnn</i> (min: 2, max: 10)		Number of monitoring node trace log files
sys	n-tlog-debug	on, off		Monitoring node detailed trace log
sys	group-addr	<i>nnn.nnn.nnn.nnn</i>		Management server group address
sys	server-ha	<i>nnn.nnn.nnn.nnn</i>		Secondary management server automatic migration
local	mip	<i>nnn.nnn.nnn.nnn</i>		IP address / Host name of public LAN
local	httpip	<i>nnn.nnn.nnn.nnn</i>		IP address / Host name of WWW server
local	server-election	on, off		Object of secondary management server automatic migration

*nnnn*: positive number,  
*nnn*: positive number (min: 0, max: 255)



**Note**

- The specified setting value is not checked by the `wvSetparam`. **Be aware** that the setting value is proper and correct (within a valid value) in case of setup or modification.
- Web-Based Admin View is not allowed to be started if “255.255.255.255” or any value outside the specified range is set for *nnn.nnn.nnn.nnn*.

## 4.5.2 Environment variable reference

To refer to environment variables, execute the following command from the management server or monitoring node:

`wvGetparam <environment variables>`

The environment variable corresponding to the specified variable is displayed in the following format:

**Display format :**

`<Attribute>:<Environment variable name> <Value>`

When this variable `<environment variables>` is eliminated, the information related to all variables is displayed in the format above.

**EXAMPLES :**

1. Normal result  
Accessing the primary management server  

```
# /etc/opt/FJSVwvbs/etc/bin/wvGetparam primary-server  
sys:primary-server 10.20.30.40
```
2. Abnormal result  
If the specified variable is inappropriate, the following message appears.  
"No such key `<specified environment variable>`"

## 4.5.3 Environment variable modification

To change an environment variable, execute the following command on the host:

`wvSetparam <environment-variable> <setting-value>`

The specified value is set to the variable "environment variable". When executed, the modified value is displayed in the following format:

**Display format :**

`<Attribute>:<Environment variable name> <Value>`

**EXAMPLES :**

1. Normal result  
Changing the display language  

```
# /etc/opt/FJSVwvbs/etc/bin/wvSetparam locale english  
usr:locale english
```
2. Abnormal result  
If the specified variable is inappropriate, the following message appears.  
"No such key `<specified environment variable>`"





### Note

- The specified setting value is not checked by the `wvSetparam`. When setting or modifying, **be aware** that the setting value is proper and correct (within a valid value).  
For the effective range of the setting value, refer to 4.5.1 "Environment variable."
- When modifying the value of the variable whose attribute is "sys", be sure to set up the same value on all the management servers and monitoring nodes.
- After modifications are made, restart Web-Based Admin View. Refer to 3.7 "Restart Web-Based Admin View."

## 4.6 Authentication environment setup

This section describes the environment variable for authentication of Web-Based Admin View.

### Operation environment variable for authentication

Attribute	Environment variable	Setting value	Description
sys	login-retry	<i>nnn</i> (positive number) [time] <b>0</b> : non-stop <b>undefined</b> : 5 times	The number of failed login attempts that will be allowed before any further login attempts are prohibited for some preset "login-inhibit-time."
sys	login-inhibit-time	<i>nnn</i> (positive number) [minute] <b>undefined</b> : 30 min <b>Minimum</b> : 10 min	Inhibiting time at login.



#### Point

Since the operation environment variable for authentication is not set when installed, the initial value is **undefined**.

#### ◆ Procedure

Take the following steps to set up operation environment variable for authentication.

1. Set up the operation environment variable for authentication.

Execute the following command (wvSetparam) on all management servers.

```
# cd /etc/opt/FJSVwvbs/etc/bin
# ./wvSetparam -add <Attribute> <Environment variable> <Setting value>
<Attribute>:<Environment variable> <Setting value>
```

The set value is output when executing the command. Check if the value is correct.

#### Example:

```
# ./wvSetparam -add sys login-retry 10
sys:login-retry 10
# ./wvSetparam -add sys login-inhibit-time 20
sys:login-inhibit-time 20
```

2. Restart Web-Based Admin View.

Restart to validate the setup on all management server.

Refer to 3.7 "Restart Web-Based Admin View."

# Chapter 5 Web-Based Admin View log reference

---

---

## **Target users**

Users who belong to the Web-Based Admin View administrator group

## 5.1 Log type

The two types of log files are described below.

### **Login log file**

To save records of all logins and logouts session to the Web-Based Admin View.

Login: The beginning of each client session where the user authenticates themselves to the system.

Logout: The termination of a client session.

### **Operation log file**

To save records of operations in the Web-Based Admin View GUI screen.

## 5.2 Log file display

This chapter describes the method of displaying log files.

Login log and Operation log can be referred to on a logging view screen.

### 5.2.1 Logging view startup

Start the logging view as described below.

**Target users:** Users who belong to the Web-Based Admin View administrator group

- Select the [Common] button on the Web-Based Admin View menu.

#### Web-Based Admin View menu

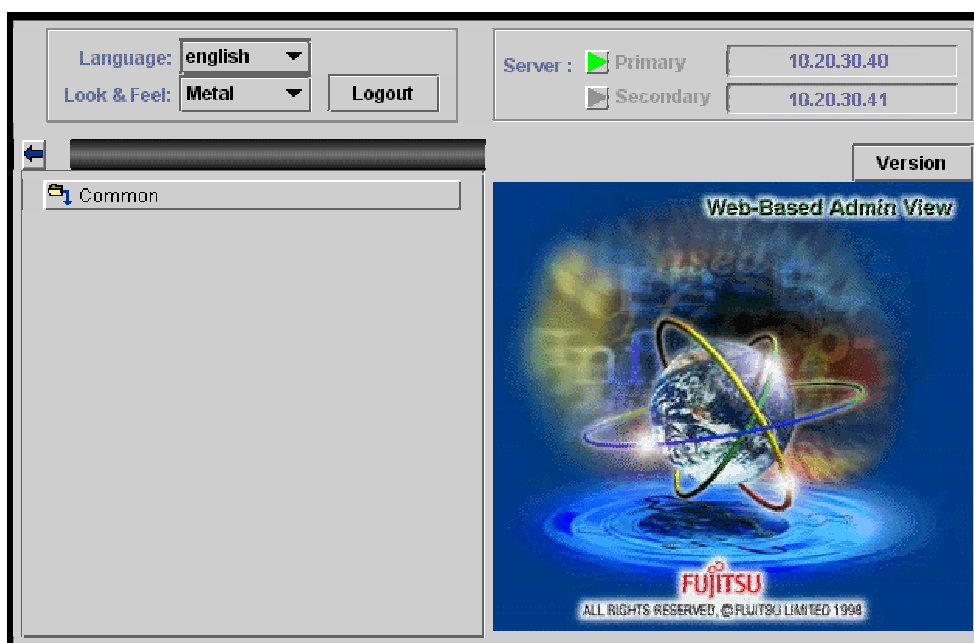

- Select the < Logging view > on the [Common] operation menu.

#### Common operation menu

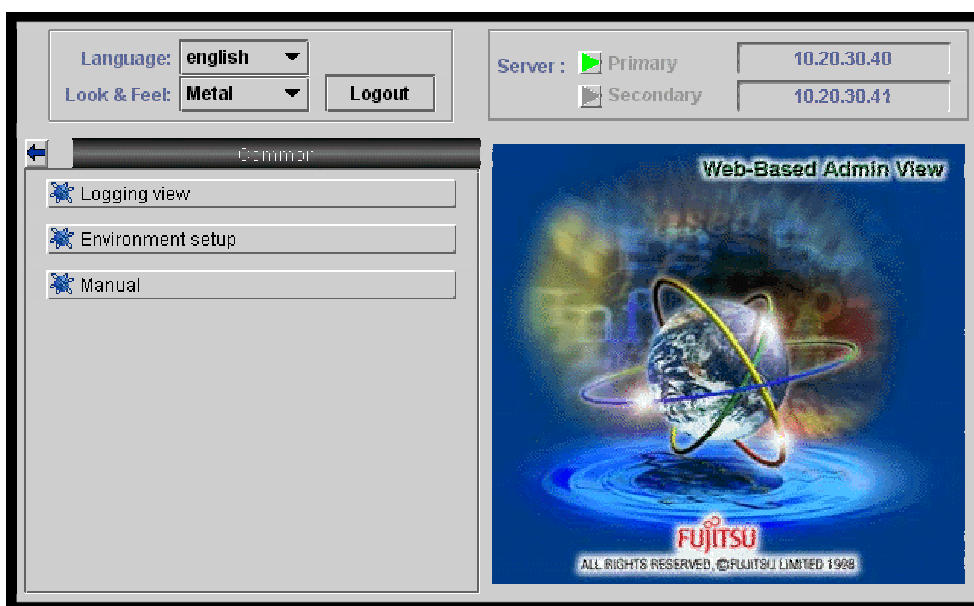

The logging view screen is displayed.

## 5.2.2 Login log

Select [Login log] on the logging view screen. The <Login Log> screen is displayed.

The usage of login log is described as following:

### ■ Narrowing down the login log

#### Logging view screen (Setup screen for login log display)

The screenshot shows a web-based interface for viewing logs. The window title is 'Logging view'. It features a menu bar with 'View' and 'Help'. Below the menu bar are two tabs: 'Login log' (selected) and 'Operation log'. The main content area is divided into three sections:

- View range:** Contains 'Start time' and 'End time' fields. Each field has dropdown menus for Year (Y), Month (M), Day (D), Hour (h), and Minute (m). The start time is set to 2001 Y, 11 M, 7 D, 21 h, 7 m. The end time is set to 2001 Y, 11 M, 8 D, 21 h, 7 m.
- Search:** Contains two text input fields: 'User name' and 'Keyword'. A 'Show' button is located to the right of these fields.
- Table:** A table with three columns: 'Time', 'User name', and 'Message'. The table is currently empty.

At the bottom of the window, there is a 'Status:' label and a 'Next' button.

#### **Start time**

Input time the log was started.

#### **End time**

Input time the log was completed.

#### **User name**

Input one user name.

#### **Keyword**

Input details to further narrow down. The keyword is valid in the message contents.

Select < Show > after specifying the conditions to display the login log.

The logs can be shown up to 200 lines at one time.

## ■ Referring to login log

### Logging view screen (Login log display screen)

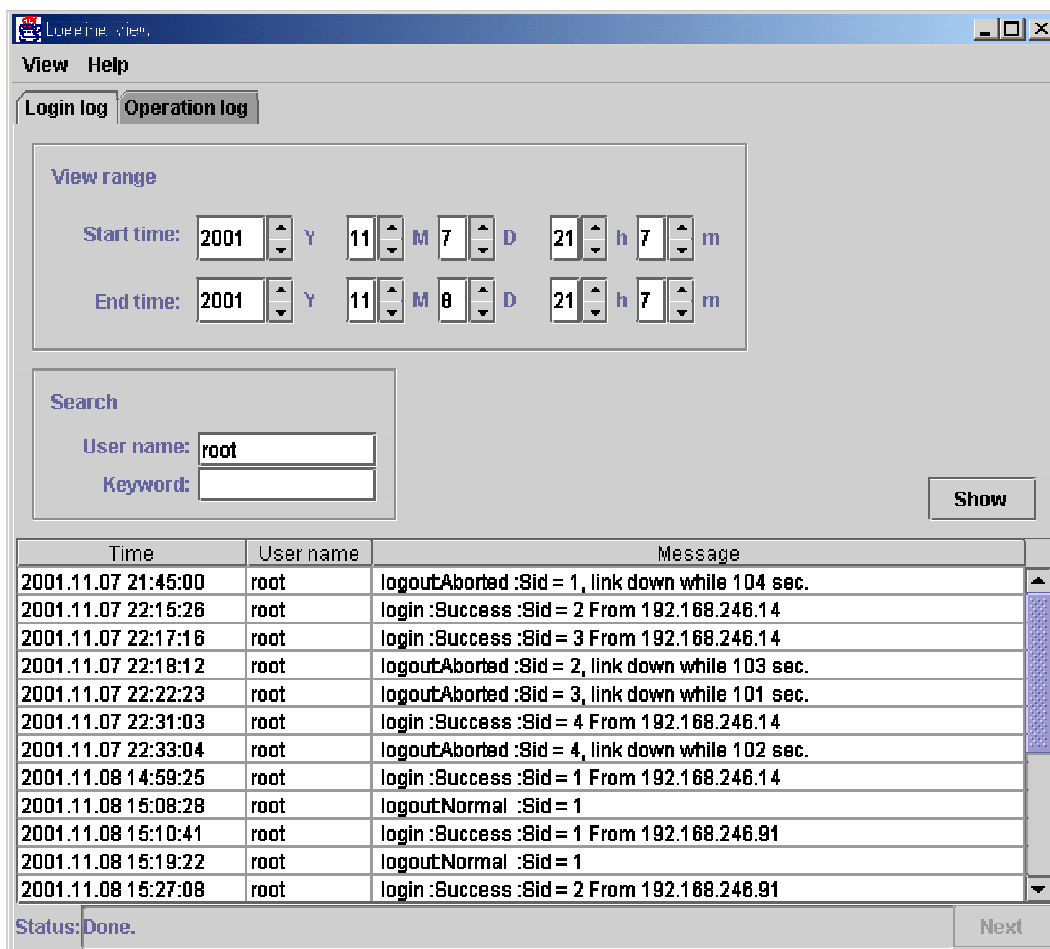

The screenshot shows a window titled "Logging view" with a menu bar containing "View" and "Help". Below the menu bar are two tabs: "Login log" (selected) and "Operation log".

Under the "Login log" tab, there is a "View range" section with two rows of date and time pickers. The "Start time" is set to 2001 Y 11 M 7 D 21 h 7 m. The "End time" is set to 2001 Y 11 M 8 D 21 h 7 m.

Below the "View range" section is a "Search" section with two input fields: "User name" containing "root" and "Keyword" which is empty. A "Show" button is located to the right of the "Keyword" field.

The main area of the window displays a table with the following columns: "Time", "User name", and "Message". The table contains 13 rows of log entries. The status bar at the bottom left shows "Status: Done." and a "Next" button is on the bottom right.

Time	User name	Message
2001.11.07 21:45:00	root	logoutAborted :Sid = 1, link down while 104 sec.
2001.11.07 22:15:28	root	login :Success :Sid = 2 From 192.168.246.14
2001.11.07 22:17:16	root	login :Success :Sid = 3 From 192.168.246.14
2001.11.07 22:18:12	root	logoutAborted :Sid = 2, link down while 103 sec.
2001.11.07 22:22:23	root	logoutAborted :Sid = 3, link down while 101 sec.
2001.11.07 22:31:03	root	login :Success :Sid = 4 From 192.168.246.14
2001.11.07 22:33:04	root	logoutAborted :Sid = 4, link down while 102 sec.
2001.11.08 14:59:25	root	login :Success :Sid = 1 From 192.168.246.14
2001.11.08 15:08:28	root	logoutNormal :Sid = 1
2001.11.08 15:10:41	root	login :Success :Sid = 1 From 192.168.246.91
2001.11.08 15:19:22	root	logoutNormal :Sid = 1
2001.11.08 15:27:08	root	login :Success :Sid = 2 From 192.168.246.91

The system shows the following items:

- **Time**  
Shows the times and dates of login and logout in the [YYYY.MM.DD.hh.mm.ss] format.
- **User name**  
Shows the name of login/logout user.
- **Message**
  - login or logout
  - succeed or fail (if fail, the reason)
  - logged-in client host name
  - session ID



#### Note

Since the log display cannot be returned to a previous screen, narrow down the search conditions, or reselect the <Show> button.

The logs can be shown up to 200 lines at one time.

## 5.2.3 Operation log

Select the [Operation log] tab on the logging view screen. The <Operation log> screen is displayed.

The usage of operation log is described as following:

### ■ Narrowing down the operation log

#### Logging view screen (Setup screen of operation log)

The screenshot shows a web browser window titled "logging view". At the top, there is a "View" menu and two tabs: "Login log" and "Operation log". The "Operation log" tab is selected. Below the tabs, there is a "View range" section with two rows of time selection: "Start time" and "End time". Each row has dropdown menus for Year (2001), Month (11), Day (8), Hour (15), and Minute (58). Below the time selection is a "Search" section with two input fields: "User name" and "Keyword", and a "Show" button. At the bottom of the window, there is a table header with columns "Time", "Username", and "Message", and a "Status" field with a "Next" button.

Specify which operation log should be displayed.

#### **Start time**

Input time the log was started.

#### **End time**

Input time the log was completed.

#### **User name**

Input one user name.

#### **Keyword**

Input details to further narrow down. The keyword is valid in the message contents.

Select the < Show > button after specifying the conditions to display the operation log.

The logs can be shown up to 200 lines at one time.



## ■ Referring to operation log

### Logging view screen (Operation log display screen)

The screenshot shows a software interface for viewing operation logs. It includes a 'View range' section with 'Start time' and 'End time' pickers, a 'Search' section with 'User name' and 'Keyword' input fields, and a 'Show' button. Below these is a table with columns 'Time', 'User name', and 'Message'. The table contains 10 rows of log entries. At the bottom, there is a 'Status: Done.' label and a 'Next' button.

Time	User name	Message
2001.11.07 19:52:45	root	[1]FaultMsgServerImpl.getMenuClass
2001.11.07 19:52:45	root	[1]OK
2001.11.07 21:30:20	root	[2]FaultMsgServerImpl.cireply -n 1 no : acacia(acacia)
2001.11.07 21:30:20	root	[2]OK
2001.11.07 21:30:21	root	[3]FaultMsgServerImpl.cireply -n 2001 no : lilac(lilac)
2001.11.07 21:30:23	root	[3]OK
2001.11.07 22:15:32	root	[4]FaultMsgServerImpl.getMenuClass
2001.11.07 22:15:32	root	[4]OK
2001.11.07 22:18:38	root	[5]safedisk.management.server.WebViewManagementServer.setSessl...
2001.11.07 22:18:38	root	[5]OK
2001.11.07 22:18:43	root	[6]safedisk.management.server.WebViewManagementServer.getNodes
2001.11.07 22:18:43	root	[6]OK

#### Time

Shows the times and dates of user operations in [YYYY.MM.DD.hh.mm.ss] format.

#### User name

Shows the user name.

#### Message

Shows user operation contents and results.



#### Note

Since the log display cannot be returned to a previous screen, narrow down the search conditions, or reselect the <Show> button.



# **Part 4      Changing the Web-Based Admin View settings**

---

---

This part explains the procedure for changing the settings after Web-Based Admin View is installed.



## Chapter 6 Changing the Settings

---

This chapter explains procedures for changing information to the items and configuration that were set initially.

The chapter covers the following procedures:

- Changing the IP address of the public LAN.
- Changing the network service port number that is used by the Web-Based Admin View.
- Changing the management server.
- Changing the secondary management server automatic migration.
- Changing the management server to a split-network environment.

## 6.1 Changing an IP Address on the Public LAN

The IP address of the public LAN that is used by the Web-Based Admin View is set up when Web-Based Admin View is installed.

The IP address of the public LAN is changed using the following procedure:

1. Stop Web-Based Admin View.

While referring to 3.6 "Stopping Web-Based Admin View," stop Web-Based Admin View running on the management server or monitoring node to change the IP address.

2. Edit the definition file.

Execute the following command:

```
# /etc/opt/FJSVwvbs/etc/bin/wvSetparam mip <IP address of public LAN>
# /etc/opt/FJSVwvbs/etc/bin/wvSetparam httpip <IP address used for
client>
```

For example, execute the following to change the <IP address of public LAN> to "100.100.100.100":

```
# /etc/opt/FJSVwvbs/etc/bin/wvSetparam mip 100.100.100.100
```

Similarly, execute the following to change the <IP address used for clients> to "100.100.100.100":

```
# /etc/opt/FJSVwvbs/etc/bin/wvSetparam httpip 100.100.100.100
```

3. Change the management server.

If the node is a management server, see 6.3 "Changing the management server," and change the management server settings.

4. Restart Web-Based Admin View.

While referring to 3.7 "Restart Web-Based Admin View", restart Web-Based Admin View on the management server or monitoring node on which the IP address is changed.



### Note

- When SynfinityCluster is used, an interface or IP address for which MAC address takeover is set up cannot be used for Web-Based Admin View as the public LAN.
- <IP address used for client> might not be required to modify when <IP address of public LAN> and <IP address used for client> is different. httpip is described <IP address used for client>, mip is described <IP address of public LAN>.

## 6.2 Changing a Network Service Port Number

With the Web-Based Admin View, system parameters and operational environment for Solaris OS are used as follows:

- Port number that is used for the http protocol
- Port number that is used for Java RMI
- Java operation environment bundled with Solaris OS

Change these parameters when the Web-Based Admin View does not normally operate or when these system parameters are conflicting with other products.

### 6.2.1 Changing a Http Port Number

"8081" is assumed to be the initialization number of the port in order to access the management server of the Web-Based Admin View from the client Web browser.

To change the settings, execute the following command for all the management servers and monitoring nodes:

```
# /etc/opt/FJSVwvbs/etc/bin/wvSetport fjwv-h=<port number>
```

To confirm the port number that is currently set, execute the following command for all the management servers and monitoring nodes.

```
# /etc/opt/FJSVwvbs/etc/bin/wvSetport fjwv-h
8081
```



#### Note

If a change is made during the operation, note the following points:

- Changes must be performed in a single user mode.
- Port numbers are controlled as the cluster service names having "fjwv-h" in all cluster management servers and in the /etc/services files on the cluster node.
- When using the products such as InfoProxy, InfoSearcher, InfoDispatcher, and Safeauthor, be sure to change the port numbers.
- If a URL is registered as a bookmark with the browser, change the port number of that URL, too.

After changes are made, restart Web-Based Admin View while referring to 3.7 "Restart Web-Based Admin View."

### 6.2.2 Changing RMI Port Numbers

With the Web-Based Admin View, four port numbers, that is, 9396, 9397, 9398, and 9399 are used in order to use the RMI function in the Java operational environment.

When changes are made, confirm that no client is available for whom the Web-Based Admin View is active before you execute the following command for all management servers and monitoring node:

```
# /etc/opt/FJSVwvbs/etc/bin/wvSetport { fjwv_c=<port number> |
fjwv_n=<port number> | fjwv_s=<port number> | fjwv_g=<port number> }
```

To confirm port numbers that are currently set up, execute the following command for all management servers and monitoring node:

```
# /etc/opt/FJSVwvbs/etc/bin/wvSetport fjwv_c fjwv_n fjwv_s fjwv_g
```

After changes are made, restart Web-Based Admin View while referring to 3.7 "Restart Web-Based Admin View."

**Note**

- Changes must be performed in a single user mode.
- Each port number is managed in all `/etc/services` files of all host computers as service names having "fjwv\_c", "fjwv\_n", "fjwv\_s", and "fjwv\_g".
- Changes must always be made with all management servers and monitoring nodes while setting the port numbers to the same values as those related to each service name.
- If the setup is modified, and the daemon is restarted on the client running Web-Based Admin View, a message stating "0007 Management server session disconnected. Do you want to try to re-connect working Management Server ?" may appear on the Web browser screen.

**Information**

For details on Remote Method Invocation (RMI), see the Sun Microsystems Documents.

## 6.2.3 Changing Java Environment

Web-Based Admin View uses the Java environment that is bundled with Solaris OS.

When the Java environment other than that bundled with Solaris OS, the following command must be executed for each cluster management server and cluster node in order to set up the Java environment library again:

```
# /etc/opt/FJSVwvbs/etc/bin/wvSetparam java_home <JDK install
directory>
```

For example, if JDK1.1.8 is installed into the directory indicated by `/opt/local/jdk1.1.8`, execute the following:

```
# /etc/opt/FJSVwvbs/etc/bin/wvSetparam java_home /opt/local/jdk1.1.8
```

After changes, be sure to restart Web-Based Admin View.

**See**

For the reactivation of Web-Based Admin View, refer to 3.7 "Restart Web-Based Admin View."

**Note**

- Changes must be performed in a single user mode.
- Each port number is managed in all `/etc/services` files of all host computers as cluster service names having "fjwv\_c", "fjwv\_n", "fjwv\_s", and "fjwv\_g".
- Changes must always be made with all cluster management servers and cluster nodes while setting port numbers the same values as that related to each cluster service name.
- If the daemon is restarted after the setting is changed while a client has an active Web-Based Admin View, the following messages may appear on the Web browser screen: "0002 Management server session disconnected. Do you want to connect to another Management Server? " "0003 Management server session disconnected. Do you want to re-connect?"

**Point**

If the OS is left installed as is under Solaris 2.6/7/8, the Java environment supported by



Web-Based Admin View will be available in /usr/java1.1. Therefore, the Java environment can be specified by executing the following command:

```
# /etc/opt/FJSVwbs/etc/bin/wvSetparam java_home /usr/java1.
```

## 6.3 Changing the management server

When the management server of the Web-Based Admin View is to be changed for some reason, be sure to set up the following:

Settings can be divided into two types: settings while executing a command for each server or monitoring node and settings from the environment setting screen.



### Information

These settings are made in static operation mode with which primary and secondary management servers are fixed. For the settings with which the secondary management servers are dynamically operated, refer to 6.4 "Changing the secondary management server automatic migration."

### ■ Setting with a command

#### ◆ Operation:

1. Stop Web-Based Admin View.  
Stop Web-Based Admin View in all management servers and monitoring nodes.



See

For stopping Web-Based Admin View, refer to 3.6 "Stopping Web-Based Admin View."

2. Set up the IP address of the management server.  
Execute the following command for all the management servers and monitoring nodes:  

```
#/etc/opt/FJSVwvbs/etc/bin/wvSetparam primary-server <IP address of primary management server>
#/etc/opt/FJSVwvbs/etc/bin/wvSetparam secondary-server <IP address of secondary management server>
```

#### Example:

When the IP addresses of primary management server and secondary server are set to "10.20.30.40" and "10.20.30.41":

```
# /etc/opt/FJSVwvbs/etc/bin/wvSetparam primary-server 10.20.30.40
# /etc/opt/FJSVwvbs/etc/bin/wvSetparam secondary-server 10.20.30.41
```

3. Change the public LAN IP address of the management server.  
While referring to 6.1 "Changing an IP Address on the Public LAN", change the IP address on the public LAN to that set up, as described above, with the primary management server or secondary management server.
4. Set up an IP address for the client on the management server.  
While referring to 6.5 "Using the Management Server in a Split-network Environment", set up the IP address to be opened for the clients to the IP address of the public LAN that the relevant management server uses or to an any IP address.
5. Restart Web-Based Admin View. Restart it for all management servers and monitoring nodes.



See

For the procedure to restart Web-Based Admin View, refer to 3.7 "Restart Web-Based Admin View."

## ■ Setting from the Environment Setting screen

### ◆ Operation:

1. Access to the primary management server from the Web browser.
2. Select [Common]-[System Environment] tab on [Environment setting], then perform settings for [Primary management server IP address] and [Secondary management server IP address].

Note that [Secondary management server IP address] cannot be set up if [Secondary management server automatic selection] is set to "Yes."

3. Set up the IP address of a public LAN.  
Refer to 6.1 "Changing an IP Address on the Public LAN." Modify the IP address of each public LAN on the primary management server and the secondary management server.
4. Set up the IP address for the client.  
Refer to 6.5 "Using the Management Server in a Split-network Environment." Modify the IP address for the clients to the IP address of the public LAN that the relevant management server uses, or to an optional IP address.



#### Note

Because an IP address to be used for the clients cannot be set up from the Environment Setting, set it up with the `wvSetparam` command while referring to 6.5 "Using the Management Server in a Split-network Environment".

5. Login to the Web-Based Admin View screen, again.  
When the environment setup is completed, the message "0051 In order to make the settings valid, restart Web-Based Admin View and reconnect it. Are you sure?" appears. If you need to validate the currently chosen value, select [Yes]. Log off, and then login the management server again. If [No] is selected, the setup remains invalid.  
Refer to the message "0051" of A.4.1 "Information message."



#### Note

When changes are made on the environment setting screen, values may not be validated equally for the monitoring node that was not active when changes were made. In that case, use a change command while referring to "Setting with a command" above.

## 6.4 Changing the secondary management server automatic migration

The following shows the setup method how a monitoring node can be automatically operated when the secondary management server is down.

1. Prepare the address used on the network  
To make this setup valid, a multicast address used on the network or a broadcast address is required. It must be pre-assigned from the network administrator.
2. Setup the secondary management server automatic migration  
Two types of settings are available:
  - executing a command  
Refer to 6.4.1 "Setup by command."
  - setting from the environment setup screen  
Refer to 6.4.2 "Setting from environment setup screen."
3. Access method from a client to the management server  
When this setup is valid, it might not be identifiable which monitoring node is used for the secondary management server when the client accesses to the management server. In such a case, access from a client to the management server following the instructions described in 6.4.3 "Access method."



### Note

- The monitoring node where this setup was done might be running as a secondary management server. In order to differentiate the IP address for the client from the IP address of the public LAN, set up the IP address for the client. Refer to 6.5 "Using the Management Server in a Split-network Environment".
- Note that this function is not available when the public LAN is multiplexed by SynfinityLink..

### 6.4.1 Setup by command

#### ◆ Procedure:

1. Stop Web-Based Admin View.  
Execute the following command on the monitoring node:  

```
# /etc/opt/FJSVwvbs/etc/bin/wvCnt1 stop
```

  
Execute this command on **all** potential monitoring nodes of the secondary management server.
2. Determine a potential monitoring node of the secondary management server.  
Execute the following command on the monitoring node:  

```
# /etc/opt/FJSVwvbs/etc/bin/wvSetparam server-election on
```

  
Execute this command on **all** potential monitoring nodes of the secondary management server.
3. Start Web-Based Admin View.  
Execute the following command on the monitoring node:  

```
# /etc/opt/FJSVwvbs/etc/bin/wvCnt1 start
```

  
Execute this command on **all** potential monitoring nodes of the secondary management server.
4. Set up a group address.  
Execute the following command on the primary management server to set up a group

address:

```
# /etc/opt/FJSVwvbs/etc/bin/wvSetparam group-addr <group address>
```

5. Set the secondary management server to the mode in which a dynamic decision is available.

Execute the following command on the primary management server:

```
# /etc/opt/FJSVwvbs/etc/bin/wvSetparam server-ha on
```

6. Validate settings.

Restart Web-Based Admin View on the primary management server.



See

Refer to 3.7 "Restart Web-Based Admin View."



Information

When a multicast address is set to a group address, for example, the IP address of the primary management server is 10.20.30.40, override 231.20.30.40 by changing "10" to "231."

For details of the group address information, refer to "RFC1700."

## 6.4.2 Setting from environment setup screen

There are methods of "Doing setup" and "Undoing setup" to set from environment setup screen.

### ■ Doing setup

Take the following steps to access to the primary management server via the Web browser.

#### ◆ Procedure:

1. Determine a potential monitoring node of the secondary management server.
  - a) Select the [Node environment] tab on the environment setup screen, and select a potential monitoring node of the secondary management server from [Node].
  - b) Select [Server environment].
  - c) Set [Object of secondary management server automatic migration] to "Yes."  
This setting must be selected from [Node] for all potential monitoring nodes of the secondary management server.
2. Set the secondary management server to the mode in which a dynamic decision is available.
  - a) Select the [System environment] tab.
  - b) Select "Yes" from [Secondary management server automatic migration] of the [Secondary server] property.
3. Set up a group address.
  - a) Select the [System environment] tab.
  - b) Set "Multicast address" or "Broadcast address" to [Management server group address] of the [Secondary server] property.
4. Validate settings.

When settings are completed, terminate the environment setup.

The message, "0051 In order to make the settings valid, restart Web-Based Admin View and reconnect it. Are you sure?" appears. If you need to validate the currently chosen value, select [Yes]. Log off, and then login the management server again. If [No] is selected, the setup remains invalid.

## ■ Undoing setup

To return settings, access to the primary management server from the Web browser as follows:

### ◆ Procedure:

1. Set the secondary management server to the mode in which a dynamic decision is not available.
  - c) Select the [System environment] tab from the environment setup screen.
  - d) Select "No" from [Secondary management server automatic migration] of the [Secondary server] property.
2. Validate settings.

When settings are completed, terminate the environment setup.

Then, the message, "0051 Do you wish to restart Web-based Admin View and login again to validate the value?" appears. If you need to validate the value, select [Yes]. If [No] is selected, the setup remains invalid.



#### Note

The modifications done on the environment setup screen might not be effective if the monitoring node was inactive. In such a case, refer to 6.4.1 "Setup by command".

## 6.4.3 Access method

If you setup the secondary management server automatic migration, it might not be identifiable which monitoring node is used for the secondary management server when the client accesses to the management server.

In such a case, describe URL when accessing from the client, as shown below. Then, the running primary or secondary management server is automatically connected:

#### When the Java Plug-in is not used

```
http://<host-name>:<port-number>/WebView.cgi
```

#### When the Java Plug-in is used

```
http://<host name>:<port-number>/Plugin.cgi
```

#### When a Swing class file is set up

```
http://<host-name>:<port-number>/Swing.cgi
```



#### Note

- Specify an optional management server or monitoring node for the host name.
- When accessing from a client by using this function, the actually connected management server is not always a monitoring node designated in URL. In order to connect by designating the primary or secondary management server, click the [Management server switching] button in the upper right of the Web-Based Admin View screen while the login screen is displayed after accessing to an optional management server or monitoring node. For details of Management server switching button, refer to 3.5.2 "Switching the Management Server to Be Connected."

## 6.5 Using the Management Server in a Split-network Environment

Web-Based Admin View can be used to set up an IP address that the management server opens for the clients to another IP address that differs from that of the public LAN that is used by that management server.

Although the IP address of the public LAN used by the management server is identical to the IP address that is available to the clients, normally, set up the IP address for the clients and the IP address for the public LAN differently when using the management server in a split-network, by applying the following procedure:



### Note

- These values cannot be omitted. Even if a different IP address not to be set, be sure to set up the same IP address as that of the public LAN, in accordance with each setting method.
- When "SynfinityCluster/HA for Netcompo" is used, cannot use this setting.

### ■ Setting with a command

Perform the following procedure with the primary management server and the secondary management server.

#### ◆ Operation:

1. Set up the network address

Login to the primary or secondary management server to execute the following commands: The "mip" value designates the IP address for Public LAN of the primary or secondary management server.



### Note

When modifying the "mip" value, it's necessary to set the primary and secondary management servers again on all monitoring nodes and all management servers. For the setup each of management server, refer to 6.3 "Changing the management server."

```
# /etc/opt/FJSVwvbs/etc/bin/wvSetparam mip <IP address of public LAN>
# /etc/opt/FJSVwvbs/etc/bin/wvSetparam httpip <IP address used for client>
```

### Examples:

In the following configuration, set up the "mip" and "httpip" as follows.

```
# /etc/opt/FJSVwvbs/etc/bin/wvSetparam mip 10.20.30.40
# /etc/opt/FJSVwvbs/etc/bin/wvSetparam httpip 192.168.246.40
```

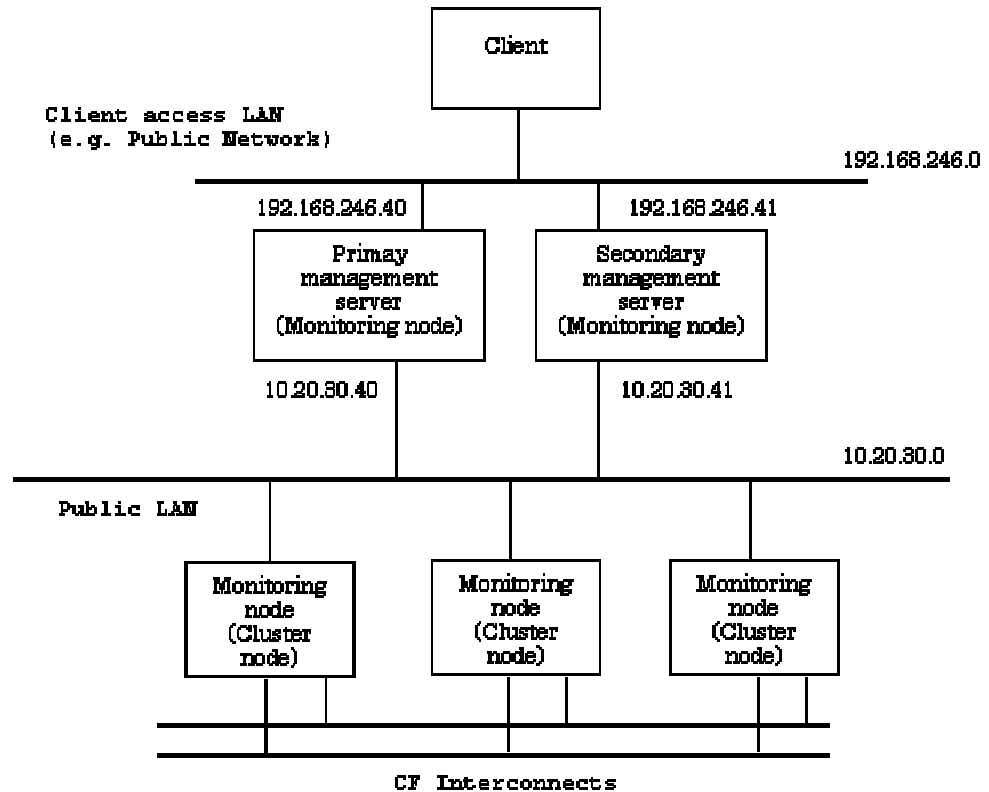

- After changes are made, restart Web-Based Admin View while referring to 3.7 "Restart Web-Based Admin View."



**Note**

- If clients are placed on the public LAN network in the cluster topology to which this setting is performed, the routing information - with which communication request to client-use IP address can be transferred to the address that is defined as LAN IP - must be set in the client.
- To perform settings again with which an access from clients is available using public LAN, Web-Based Admin View must be restarted after execution of the following command, while referring to 3.7 "Restart Web-Based Admin View."

```
# /etc/opt/FJSVwvbs/etc/bin/wvSetparam httpip <IP address of public LAN>
```

■ **Setting from the Environment Setting screen**

Access the primary management server via the Web browser to perform the following settings: Note that only the IP address and host name of the public LAN can be set up on the Environment Setting screen. When changing an IP address that is used for the clients, use the above-mentioned "Setting with a command" above to make the setting.

◆ **Operation:**

- Select a management server for which setting is to be made.  
Select the [Node Environment] tab with the environment setting screen, and select a management server to separate the network, from [Target Node].
- Set an IP address or a host name.  
Select the [IP address/Host name] item and set an IP address or host name that is used for the public LAN for [IP address/Host name of public LAN].
- Validate settings.  
After settings are complete, exit the environment setting.



When the environment setting is terminated after changes are made, the message, "0051 In order to make the settings valid, restart Web-Based Admin View and reconnect it. Are you sure?" is output. If you wish to validate the value immediately, select [Yes]. After performing logoff, login the management server.



**Note**

When you are using the method described in "Setting from the Environment Setting screen," the settings may not be correctly reflected upon a cluster node or other that is not active at setting. In such a case, use a command to perform setup.



# Appendix A Message

This appendix provides information on message associated with Web-Based Admin View, and wherever possible, a recovery procedure is provided to locate and correct the problem.

## A.1 Message reference

This section explains how to refer to a message.

### ■ Message display style

Web-Based Admin View displays a following message dialog:

#### Message dialog

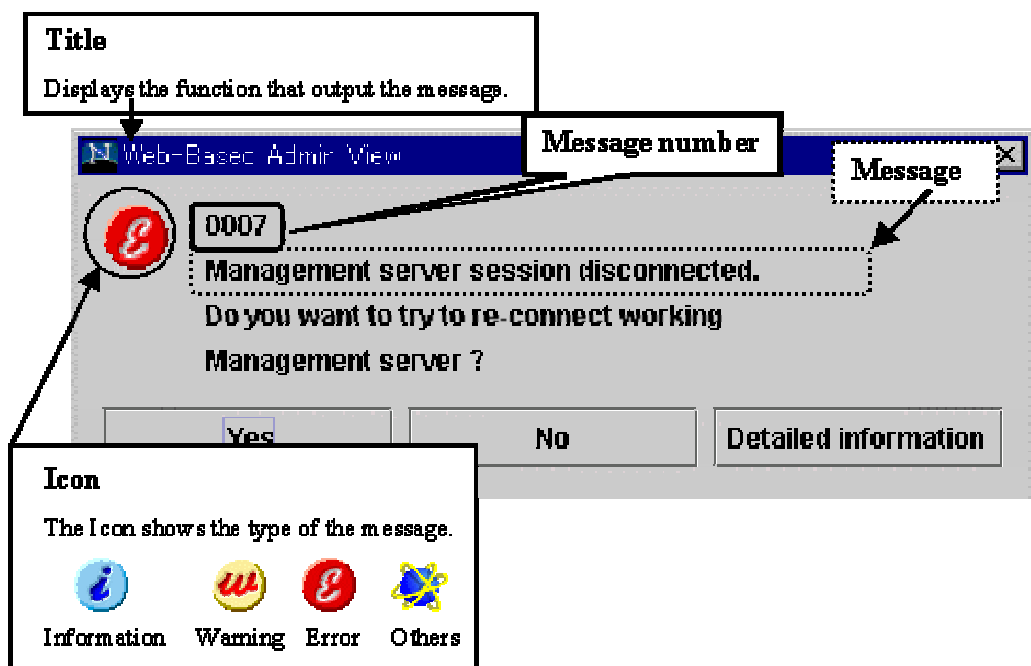







For details on the function (title) displayed by Web-Based Admin View, see the TABLE A-1 "Message dialog messages".

### ■ Refer to message

Message dialog contains the description of function(title), type(icon), and a unique number.

If you do not quite understand the meaning of a message or action, take a note of the message text, the message number, and look up the message in the following table:

TABLE A-1 Message dialog messages

Function (title)	Message number	Type (Icon)
A.2 Web-Based Admin View message	A.2.1 0001-0044	
	A.2.2 0001-0044	
A.3 Log reference message	A.3.1 0045-0049	
	A.3.2 0045-0049	
A.4 Environment setup message	A.4.1 0051-0059	
	A.4.2 0051-0059	
	A.4.3 0051-0059	



See

If the title of the message is other than those above, the manual for each product described in the title, and then take appropriate actions.

## A.2 Web-Based Admin View message

### A.2.1 Information message

**0020 This application cannot launch with a secondary Management Server specified.**

**Please specify a primary Management Server.**

**Corrective action**

Connect to the primary management server and start this application.

**0021 This application must be started up with following URL on another browser window.**

**Corrective action**

Select [OK] to exit all running applications, and then re-access the recommended URL.

**0022 Re-connect to following URL. Do you want to connect?"**

**Corrective action**

Select Yes or No.

- Click [Yes]. Active management server is retrieved and connection is attempted.
- Click [No] to end the connection.

**0023 This application must be started up with following URL on another browser window.**

**Corrective action**

Click [Yes] to access by the specified URL.

When the activated Web browser is Internet Explorer, access the designated URL again via Netscape Communicator.

**Reference problem**

"Symptom 14" in "Troubleshooting"

---

## A.2.2 Error message

---

### 0001 Cannot call Management server.

**Corrective action 1**

In most cases, the management server might not be able to respond to the request from the client, or the response from the server might be extremely slow. Click <OK> and call a management server again.

**Corrective action 2**

If the corrective action 1 does not work, the Web browser might not be operating normally. Exit the Web browser, and then, restart the Web-Based Admin View screen, or reboot the client first.

**Reference problem**

"Symptom 1", "Symptom 9" in "Troubleshooting"

### 0003 Management server session disconnected. Do you want to re-connect?

**Corrective action**

When the system environment was modified in the environment setup, it is displayed in the client in which the setup was done. Take a proper action in the followings:

- Click [Yes] to reconnect.
- Click [No] to end the connection.
- Click [Detailed information] to display error detailed information.

### 0004 Connection refused from Management Server. Do you want to re-connect?

**Corrective action**

The network failure might have occurred, the client terminal's CPU might have been overloaded, or the system time setting of the management server might have been changed. Take a proper action in the followings:

- Click [Yes] to reconnect to another management server..
- Click [No] to end the current connection.

**Reference problem**

"Symptom 1" in "Troubleshooting"

### 0005 Cannot connect to Management. Server. Do you want to re-connect?

**Corrective action**

The management server may not have been started. Take a proper action in the followings:

- Click [Yes] to reconnect.
- Click [No] to end the connection.
- Click [Detailed information] to *display error detailed information*.

**Reference problem**

"Symptom 1", "Symptom 4" in "Troubleshooting"

### 0006 An error was detected in the Management Server environment setting.

**Corrective action 1**

The Web browser might not be operating properly. Exit the Web browser, and then, restart the Web-Based Admin View screen, or reboot the client first.

**Corrective action 2**

Refer to Take appropriate action while referring to the explanation of "Symptom 17" in troubleshooting to take an Corrective action. Still, the problem is not improved, report the contents of the Java console to local Customer Support.

**Reference problem**

"Symptom 17" in "Troubleshooting"

**0007 Management server session disconnected. Do you want to try to re-connect working Management Server?**

**Corrective action**

Select one of [Yes], [No], or [Detailed information]:

- Click [Yes] to retrieve an active management server for connection.
- Click [No] to end the connection.
- Click [Detailed information] to display error detailed information.



**Note**

This message appears if no response is received from the management server. Confirm the state of the management server or the network.

If connection is available by selecting [Yes], a temporary network load is assumed to be the cause of the disconnection. In this case, raise the "Connection monitoring time between Client and Server" of the system environment.

**Reference problem**

"Symptom 7", "Symptom 16" in "Troubleshooting"

**0015 Management Server will terminate. Please logout immediately.**

**Corrective action**

The management server is terminated. Sign off Web-Based Admin View.

**0016 login incorrect.**

**Corrective action**

Enter a correct user name and password.

**Reference problem**

"Symptom 18" in "Troubleshooting"

**0017 password incorrect.**

**Corrective action**

Enter a correct password.

**0030 Internal Error**

**Corrective action**

An error was detected in the management server environment setting. Contact local Customer Supports



**Note**

This error message appears on the page within the Web browser.

**0031 Network Error**

**Corrective action**

A network error has occurred. Restart the cluster management server and the monitored node, and then reconnect the network following the procedures described in 3.7 “Restart Web-Based Admin View.” Still, the problem is not improved, contact local Customer Supports.



**Note**

This error message appears on the page within the Web browser.

### 0032 Login Error

#### **Corrective action**

Login was failed. Sign on by a correct user ID and password.



**Note**

This error message appears on the page within the Web browser.

### 0033 Server not ready

#### **Corrective action**

Select [Reload] of the browser.



**Note**

This error message appears on the page within the Web browser.

### 0040 Invalid browser

#### **Corrective action**

Web-Based Admin View cannot be started by accessing the specified URL with this Web browser. To start from this URL, use Netscape Communicator.



**Note**

This error message appears on the page within the Web browser.

### 0041 Old Swing is installed

#### **Corrective action**

The version of the Swing class file set in the Web browser is not correct. Set a Swing class file in the correct version.



**Note**

This error message appears on the page within the Web browser.

### 0042 Swing is not installed

#### **Corrective action**

No Swing class file is set up on the Web browser, or the version is incorrect. Set up the Swing class file again as described in 3.1.3.2 “Required for the Web Browser Environment.”



**Note**

This error message appears on the page within the Web browser.

## **A.3 Log reference message**

### **A.3.1 Information message**

---

#### **0045 Invalid value found at 'Start(End)' field.**

**Corrective action**

Set the correct date and time.

#### **0046 Please put the start time earlier than the end time.**

**Corrective action**

Set the correct start and finish time.

#### **0047 There are no records. There are no appropriate logs.**

**Corrective action**

Reset the conditions and display information

### **A.3.2 Error message**

---

#### **0048 Read error occurred. Log information couldn't be gotten.**

**Corrective action**

Re-select <Show> and display information.

#### **0049 Initialize error.**

**Corrective action**

Contact local Customer Support.

## **A.4 Environment setup message**

### **A.4.1 Information message**

---

#### **0051 In order to make the settings valid, restart Web-Based Admin View and reconnect it. Are you sure?**

**Corrective action**

Select [Yes] to login again. Then, Web-Based Admin View starts automatically and outputs the message if you wish to login again after restarting. Select [Yes].

Otherwise, select [No]. The value is not enabled.

#### **0052 Do you want to terminate Environment setup to make the settings valid?**

**Corrective action**

Select [Yes] to quit environment setup and enable the setup.

Otherwise, select [No].



**0053 Do you want to cancel processing?****Corrective action**

Click [Yes] to cancel processing. Click [No] to stop cancellation.

**0054 Do you want to terminate Environment setup?****Corrective action**

Click [Yes] to exit. Otherwise, click [No].

**0059 In order to make the settings valid, restart Web-Based Admin View on the changed monitoring node and reconnect it. Are you sure?****Corrective action**

Select [Yes] to login again. Then, Web-Based Admin View starts automatically and outputs the message if you wish to login again after restarting. Select [Yes].

Otherwise, select [No]. The value is not enabled

---

**A.4.2 Warning message**

---

**0055 There is an error in the designation of XXXX.****Corrective action**

Enter the correct value.

**0058 The Web-Based Admin View may not work correctly because of the designation of XXXX. Do you want to continue?****Corrective action**

Click [Yes] to continue. If you do not wish to continue, click [No].

---

**A.4.3 Error message**

---

**0056 There is an connection error. Environment setup is canceled.****Corrective action**

A communication error occurred.

Check if the management server and monitoring node are working properly. If not, restart Web-Based Admin View as explained in 3.7 "Restart Web-Based Admin View."

**0057 There is an internal error. Environment setup is canceled.****Corrective action**

Report the contents of the Java Console to local Customer Support.



# Appendix B Troubleshooting

This part describes actions to be applied in the event of a problem occurring with Web-Based Admin View.

This appendix also explains how to maintain the SynfinityCluster system, apply software fixes to the SynfinityCluster system, and collect error data.

The target is all the users of Web-Based Admin View.

## B.1 Troubleshooting

This section explains the actions to be taken in the event of a problem occurring with the Web-Based Admin View.

First, check the corrective actions of "Symptom 1" before checking each Symptom.

**Symptom 1: The top menu of the Web-Based Admin View cannot start. Also the screen display may be abnormal or "0001"-"0005" message appears.**

### Corrective action 1

Confirm the following points:

- Is the specified URL correct?
- Is the host name specified correctly?
- Can the environment be used with Swing or Java Plug-in?  
(See 3.1.3 "Preparing the Web environment")
- Is the browser of the recommended type and level?

### Corrective action 2

Refer to 6.2.1 "Changing a Http Port Number" and confirm the http port number that is currently set up.

### Corrective action 3

Refer to Corrective action 3 for the "Symptom 4" and check that each process of Web-based Admin View is active.

### Corrective action 4

The browser may hang depending on the OS of the client or the version of the browser. In such a case, restart the browser and retry accessing the management server.

### Corrective action 5

Refer to the installation guide for the product and make sure all the required packages are correctly installed.

### Corrective action 6

Check the proxy setting of the browser not using proxy server.

Both the host name and IP address for the host name must be set not using proxy server for setting of browser and Java Plug-in.

**Symptom 2: The screen is not switched when clicking the confirmation button for 0003 or 0007-dialog message. The browser is hung up when attempting to reconnect to the management server that was previously connected.**

### Corrective action

Enter the URL of the connected management server in the URL field of the browser and switch the screen manually, or restart the browser, and then retry accessing the server.

**Symptom 3: The following message may be output to the Java console screen of the management server or monitoring node.**

**FJSVwvbs: OutOfMemoryError**

**Corrective action**

Restart the Web-Based Admin View on the management server or monitoring node on which the message appeared. Shut down/restart the client Web browser and then reaccess.



[See](#)

For the reactivation of Web-Based Admin View, refer to 3.7 "Restart Web-Based Admin View."

**Symptom 4: When the browser accesses the management server, dialog message 0005 is displayed and the top menu is not displayed.**

If the problem is not cleared even after you restart the browser, perform the following:

**Corrective action 1**

If a name is specified as the host name of the management server in the URL field of the browser, do not specify the name but the IP address of the public LAN of the management server directly. If the authentication dialog box of the Web-Based Admin View is displayed when the IP address is specified directly, the client DNS settings may be incorrect. In that case, follow the procedure shown below:

If the authentication dialog box does not appear, even when the IP address is specified directly, apply action 2.

- If the client is running Windows(R) 98  
Select [Start]-[Settings]-[Control Panel]-[Network]. For the [Configuration], select the [TCP/IP properties], and then select [DNS configuration]. If "Do not use DNS" is selected, perform Corrective action 3.  
If "Use DNS" is selected, change the values specified in [Host] and [Domain] to names that can be resolved by DNS.
- If the client is Windows NT(R)  
Select [Start]-[Settings]-[Control Panel]-[Network]. For [Protocol], select the [TCP/IP protocol] property, and then select [DNS]. If values are not set for both [Host name] and [Domain], perform Corrective action 3. If values are specified for [Host name] and [Domain], change the values to names that can be resolved by DNS.
- If the client is Windows(R) 2000  
Select [Local area connection] from <Network and dialup connection> that appears when you select [Start]-[Settings]-[Control Panel], and then select [Properties]. From the list on the [General] tag, select [Internet protocol (TCP/IP)] and then display [Properties]. If you select [Automatically acquire DNS server address] or [Use the next DNS server address], confirm whether the name is resolved with the specified DNS server. If you do not select either, apply action 3.
- If the client is Solaris Workstation  
Check whether DNS is being used for name resolution of the host name.  
Execute the following command. If the result is the character string 'dns,' the system may be using DNS.

[Example]

```
# egrep '^hosts:' /etc/nsswitch.conf
```

```
hosts:          files dns
```

If DNS is being used, execute the following command and check whether the host name specified in the URL field is always resolved.

[Example]

```
# nslookup www.fujitsu.co.jp
Server: foo.fujitsu.co.jp
Address: XXX.XXX.XXX.XXX
```

```
Name: www.fujitsu.co.jp
Address: XXX.XXX.XXX.XXX
```

If an error is displayed, the DNS setting is incorrect. Report the problem to the network administrator.

### Corrective action 2

Confirm whether a combination of the host name (local host name) indicated by `uname -n` and the IP address is registered either with the `/etc/inet/hosts` file or with the DNS. Register it either in the `/etc/inet/hosts` file or with the DNS so that a combination of the local host name and the IP address can be solved.

### Corrective action 3

Check whether the Web-Based Admin View has started on the management server.

Execute the `ps` command to check whether the following process has started correctly.

[When the monitoring node also acts as the management server]

```
wvrespawn -r20 Server java -mx32m -Djava.security.policy=/opt/FJSVwvbs/etc/.pol
wvrespawn -c -r20 Node java -mx32m -Djava.security.policy=/opt/FJSVwvbs/etc/.po
java -mx32m -Djava.security.policy=/opt/FJSVwvbs/etc/.policyAp com.fujitsu.webv
java -mx32m -Djava.security.policy=/opt/FJSVwvbs/etc/.policyAp -Dwebview.htdocs
/opt/FJSVwvbcnf/bin/wvbcnfd -b XXX.XXX.XXX.XXX -p XXXXX
```

[When the monitoring node does not act as the management server]

```
wvrespawn -c -r20 Node java -mx32m -Djava.security.policy=/opt/FJSVwvbs/etc/.po
java -mx32m -Djava.security.policy=/opt/FJSVwvbs/etc/.policyAp com.fujitsu.webv
/opt/FJSVwvbcnf/bin/wvbcnfd -b XXX.XXX.XXX.XXX -p XXXXX
```

If there is even one process that has not started, take actions as described in Corrective action 4 or "Symptom 11".

### Corrective action 4

Moreover, for all nodes, check the IP address of the public LAN, the IP address of the client, and the IP address of the management server.

```
# /etc/opt/FJSVwvbs/etc/bin/wvGetparam mip
local:mip xxx.xxx.xxx.xxx <public LAN IP address>
# /etc/opt/FJSVwvbs/etc/bin/wvGetparam httpip
local:httpip xxx.xxx.xxx.xxx <IP address for the client>
# /etc/opt/FJSVwvbs/etc/bin/wvGetparam primary-server
sys:primary-server xxx.xxx.xxx.xxx <IP address of the primary management server>
# /etc/opt/FJSVwvbs/etc/bin/wvGetparam secondary-server
sys:secondary-server xxx.xxx.xxx.xxx <IP address of the secondary management server>
```

If these parameters are not set up correctly, set correct addresses by referring to 6.1 "Changing an IP Address on the Public LAN", or 6.3 "Changing the management server", and 6.5 "Using the Monitoring Server in a Split-network Environment".

### Corrective action 5

1. Edit and access the following file on the management server:

File: /etc/opt/FJSVwvbs/etc/WebView.html

Record: < PARAM NAME=Port VALUE="????" >

2. Execute the following command:

```
# /etc/opt/FJSVwvbs/etc/bin/wvSetport fjwv_c
```

If the execution result of 2 is ????, which is the same value of VALUE in 1, follow Corrective action 6.

If the execution result of 2 is not the same as the value of VALUE in 1 (????), change the RMI port number of fjwv\_c, according to 6.2.2 "Changing RMI Port Numbers."

```
# /etc/opt/FJSVwvbs/etc/bin/wvSetport fjwv_c=<RMI port number>
```

The initial value of the RMI port number of fjwv\_c is 9399.

After changing the port number, restart Web-Based Admin View while referring to 3.7 "Restart Web-Based Admin View".

#### **Corrective action 6**

Edit the following file in the management server and retry accessing the management server:

File: /etc/opt/FJSVwvbs/etc/WebView.html

File: /etc/opt/FJSVwvbs/etc/Plugin.html

File: /etc/opt/FJSVwvbs/etc/Swing.html

Record: < PARAM NAME=Initial\_wait VALUE="???">

Specify 60 or more in "??".

After editing a file, restart Web-Based Admin View while referring to 3.7 "Restart Web-Based Admin View".

### **Symptom 5: When the IP address of the public LAN was changed, the operation of Web-Based Admin View was disabled.**

#### **Corrective action**

Change the IP address of the public LAN in accordance with 6.1 "Changing an IP Address on the Public LAN" Moreover reset the IP address that is available to management server setup and the clients, referring to 6.3 "Changing the management server" and 6.5 "Using the Management Server in a Split-network Environment".

### **Symptom 6: When using SynfinityCluster management view, the normally displayed cluster node cannot be displayed in the node list for each product.**

#### **Corrective action**

After applying the actions described for phenomena 5, restart Web-Based View in accordance with 3.7 "Restart Web-Based Admin View"

### **Symptom 7: The screen does not switch even after a response to the dialog message is specified..**

#### **Corrective action**

If the picture on the right side of the Web-Based Admin View top menu is red, click the red picture. Set the picture on the right side of the top menu of the Web-Based Admin View to "always on top" even though the message dialog is hidden under other window on the display.

### **Symptom 8: The following message is displayed on the status bar of the browser and the top menu is not displayed:**

**"Applet com.fujitsu.webview.base.WebViewMain**

**error:java.lang.NoClassDefFoundError : com/sun/java/swing/JApplet"**

**or Cluster management view for each product cannot start.**

**Corrective action**

The Swing class file may not have been set in the Web browser.

Set up the Swing class file while referring to "Setting up the Swing class file" in 3.1.3.2 "Required for the Web Browser Environment".

**Symptom 9: It takes more than several minutes for the top menu of Web-Based Admin**

**View to appear. It sometimes freezes after it appears or the message, "0001 Cannot call Management server" appears.**

**Corrective action**

Increase the [Connection monitoring time between Client and Server] for the system environment in the environment setting.

**Symptom 10: When a Java Plug-in is used with the client browser, the screen display may be abnormal, such as garbage being left around those portions where the mouse was moved, after accessing the top menu of the Web-Based Admin View or management view of each product with the mouse.**

**Corrective action**

The graphics hardware of the client may have failed. Use the graphics hardware differently or update the graphics driver. If the condition does not improve, contact your Fujitsu systems engineer (SE).

**[For Windows(R) 98]**

1. Right-click the [My Computer] icon on the desktop and then select [Properties]. The "system properties" screen appears.
2. Select the [Performance] tab, then [Graphics] of "Detail Setting." The "graphics detailed setting" screen appears.
3. Change the settings of the hardware accelerator.

**[For Windows(R) 2000]**

1. Select the [Start]-[Settings]-[Control Panel]-[Display].
2. Select the [Settings] panel of [Screen Properties], and then select [Details].
3. Select the [Troubleshooting] tab and then change the settings of the hardware accelerator.
4. Select the [Plus!] tab of [Display] and then check the box of [Show windows contents while dragging]

**[For Windows(R) XP]**

1. Select [Start]-[Control Panel]-[Display]-[Screen Properties]-[Settings]-[ System Properties ]-[Troubleshooting].
2. Change the settings of the hardware accelerator.

**[For Windows NT(R)]**

The use of the graphics hardware cannot be changed.



**Note**

- If the problem continues to occur even if you reduce the level of performance by one step when you are changing the hardware accelerator settings, confirm the occurrence of the problem by reducing the performance level one step at a time.
- If you change the use of the graphics hardware, all of the client graphic displays may be impacted. Be particularly careful when making this change. When you are not using the Web-Based Admin View, restore the setting before changing to that for Web-Based Admin View.

**Symptom 11: Web-Based Admin View does not start up with the message "FJSVwvbs: webview.cnf abnormal" or "Node process abnormal end." when starting or restarting Web-Based Admin View or when starting a node.**

**Corrective action 1**

Check the environment if the Java environment is supported by the Web-Based Admin View.

Make the check as described below:

1. Check the defined Java environment

```
# /etc/opt/FJSVwvbs/etc/bin/wvGetparam java_home  
local:java_home <path>
```

2. Check the version

Check, using the following version display command, whether the Java environment existing in <path>, acquired with the above command, is in an environment that can be used with Web-Based Admin View:

```
# <path>/bin/java -version  
java version "X.X.X"
```

If the displayed version is "1.1.X," the Web-Based Admin View can be operated.

If other than version "1.1.X" is set up, reset an appropriate Java environment by referring to 6.2.3 "Changing Java Environment".

**Corrective action 2**

Perform Corrective action 3 for "Symptom 4".

**Corrective action 3**

Check that the specified port number has not already been used by referring to 6.2 "Changing a Network Service Port Number."

**Corrective action 4**

Check whether the definition file (/etc/opt/FJSVwvbs/etc/webview.cnf) of the Web-Based Admin View is set up correctly on all the management servers or monitoring nodes.

The following is an example of the *webview.cnf* file:

**[Example of /etc/opt/FJSVwvbs/etc/webview.cnf]**

```
usr:locale:japanese  
usr:look-and-feel:Metal  
usr:out-time:0  
usr:c-tlog-debug:off  
sys:s-java-option:-mx32m  
sys:n-java-option:-mx32m  
sys:classpath:/opt/FJSVwvbs/etc/jars/swingall.jar  
local:classpath:  
sys:cluster-path:/etc/opt/FJSVcluster/bin:/etc/opt/FJSVcluster/sys  
local:cluster-path:
```



```
sys:cluster-lib-path:/etc/opt/FJSVcluster/lib
local:cluster-lib-path:
sys:primary-server:XXX.XXX.XXX.XXX
sys:secondary-server:XXX.XXX.XXX.XXX
sys:server-ha:off
sys:group-addr:XXX.XXX.XXX.XXX
sys:http-home:
sys:keep-time:10
sys:retry-time:30
sys:health-time:10
sys:n-pending-events:100
sys:rmi-cmdread-timer:900
sys:rmi-cmdwait-timer:900
sys:s-llog-vol:100
sys:s-llog-num:2
sys:s-olog-vol:100
sys:s-olog-num:2
sys:s-elog-vol:100
sys:s-elog-num:2
sys:s-tlog-vol:200
sys:s-tlog-num:2
sys:s-tlog-debug:on
sys:n-tlog-vol:200
sys:n-tlog-num:2
sys:n-tlog-debug:on
sys:tophtml-suffix:html
sys:acsif:hme0
sys:htpdif:hme0
local:mip:XXX.XXX.XXX.XXX
local:httpip:XXX.XXX.XXX.XXX
local:server-election:on
local:java_home:/usr/java1.1
local:s-log-path:/var/opt/FJSVwvbs/logs/server
local:n-log-path:/var/opt/FJSVwvbs/logs/node
```

If the webview.cnf file is not in this format, recreate the above file by using an editor such as vi.

If you find that the webview.cnf file has, in fact, been created as shown above, follow the procedure shown below to reset all the management servers and monitoring nodes using the parameters that are unique to those nodes:

1. Set up the IP address of the public LAN that is used by the node referring to 6.1 "Changing an IP Address on the Public LAN".
2. Set up the IP addresses of the primary management server and the secondary server by referring to 6.3 "Changing the management server".
3. Set up the IP address of the open network for clients when the node becomes a management server by referring to 6.5 "Using the Management Server in a Split-network Environment".
4. Set up the group address by referring to the method used for command-based setup in 6.4 "Changing the secondary management server automatic migration."
5. Restart the Web-Based Admin View.  
Restart the Web-Based Admin View by referring, refer to 3.7 "Restart Web-Based Admin View."

**Symptom 12: The message "WARNING: unrelated 'httpip' property." is output when the Web-Based Admin View is started or restarted.**

**Corrective action**

While referring to 6.5 "Using the Management Server in a Split-network Environment", confirm whether the IP address of the open network for clients is correctly set up in the management server.

**Symptom 13: The manual title is not displayed by manual reference operation after the manual package is installed, or the manual title remains after the package is deleted.**

**Corrective action**

The installation or deletion of the manual contents while the Web-Based Admin View is active will not take effect before the Web-Based Admin View is restarted. Refer to 3.7 "Restart Web-Based Admin View" and restart the Web-Based Admin View, then retry accessing from the client.

**Symptom 14: The message "0023: This application must be started with the following URL." is displayed when an attempt is made to start the operation management product from the top menu of the Web-Based Admin View.**

**Corrective action**

The access method may vary depending on the operation management product. Recheck the access method by referring to the manual of the operation management product to be used. When operation management products with different access methods are to be used simultaneously, refer to 3.3.3 "Using the Operation Management Products with Different Access Methods Simultaneously."

**Symptom 15: The start button of the operation management product disappears from the top menu of the Web-Based Admin View.**

**Corrective action**

If an incorrect access method is used when an optional operation management product is to be started, re-access may be performed automatically after the display of the "0022" message. In this case, the top menu of the Web-Based Admin View that was displayed with the first access method will be exited.

When the top menu of the Web-Based Admin View that was displayed first is to be redisplayed, start another Web browser screen and perform access on that screen again.

For details, see 3.3.3 "Using the Operation Management Products with Different Access Methods Simultaneously."

**Symptom 16: The "0003," or "0007" message may not appear even after the management server session is disconnected.**

**Corrective action**

Restart the browser and retry accessing the management server.

**Symptom 17: The "0006" dialog message is displayed and the top menu is not displayed when an attempt is made to access to the management server from the**

**browser.****Corrective action 1**

Perform Corrective action 2 for "Symptom 11".

**Corrective action 2**

Check the correct class file is specified for the client by referring to "Confirming the Swing Class File Version" in 3.1.3.1 "Preparing the Web browser".

**Symptom 18: Login fails with the "0016" message after the user ID and password are entered in the Login dialog.****Corrective action 1**

Check if the user ID and password provided is correctly registered for the Solaris.

**Corrective action 2**

If no password is assigned for the user ID, set the password.

**Corrective action 3**

The password might have been entered wrong several times in a row. Check the environment setup variable for authentication (login-retry). For details, refer to 4.6 "Authentication environment setup."

If you continue to login, follow the corrective action 4 below.

**Corrective action 4**

If the problem is not improved, reconnect from a client after restarting the management server of Web-Based Admin View. Refer to 3.7 "Restart Web-Based Admin View."

**Symptom 19: The SynfinityFile/Global manual cannot be displayed from the manual menu.****Corrective action**

The English and Japanese versions of the SynfinityFile/Global Guide cannot be displayed at the same time. Reinstall the SynfinityFile/Global Guide package by referring to the notes given in 3.3.2 "Common Menu Facilities".

**Symptom 20: The screen does not appear when Netscape Navigator or Netscape Communicator was started up. (When the Web browser was last exited, the user clicked either the [X] button at the top-right corner of the screen or [Close] on the Window menu.)****Corrective action**

Care is required because the countermeasures to be taken differ depending on the client's OS.

**[When Windows NT(R) 4.0, Windows(R) 2000, Windows(R) Me, or Windows(R) XP is being used]**

1. Press the <Ctrl> + <Alt> + <Delete> keys at the same time to launch the "task manager."
2. Select the "Process" tab, and then select netscape.exe.
3. Right-click, and then select the "end process" menu. Enter "Yes" in the dialog box that appears.
4. Using the method described in 3., exit from every instance of netscape.exe.
5. Start the Web browser.

**[When Windows(R) 98 is being used]**

1. Press the <Ctrl> + <Alt> + <Delete> keys at the same time to open the "Close Program" screen.
2. Select Netscape from the list box that appears on the screen in 1., and then press the "End" button.
3. Using the method described in 2., exit from every instance of Netscape.
4. Start the Web browser.

**[In case of System Management Console (SMC) or Solaris Workstation]**

1. Check the process ID of java\_vm\_native.  
**# ps -ef | grep java\_vm\_native**
2. Stop the process of java\_vm\_native by force.  
**# kill -9 <java\_vm\_native process ID>**  
*java\_vm\_native-process-ID: <java\_vm\_native process ID>*
3. Check the process ID of the netscape process.  
**# ps -ef | grep netscape**
4. Stop the process of Netscape by force.  
**# kill -9 <Netscape process ID>**  
*netscape-process-ID: <Netscape process ID>*
5. Start the Web browser.

**Symptom 21 : When Web-Based Admin View is restarted, the message "couldn't set locale correctly" is output after executing a command.**

**Cause**

Japanese is set in the display setting of Web-Based Admin View in the Solaris environment where the Japanese version is not installed.

**Corrective action**

Change [Language] from "japanese" to "english" for the display setting. When it is done, Web-Based Admin View is automatically restarted, so log off immediately. Refer to 4.3 "System environment".

**Symptom 22 : The cluster node is not displayed, or an access error occurs when the operation management screen is activated for the first time after Web-Based Admin View installation.**

**Corrective action**

Take the following steps to check if the setup for primary and secondary management server is properly done. For your reference, you can see 4.3.3 "Primary management server", 4.3.4 "Secondary management server".

1. Check the provided [Secondary] information in the upper right of the Web-Based Admin View screen.
2. Take proper actions according to the information.
  - In case of non-display  
Check if there's any failure or damage in the secondary management server.
    - If any, locate the cause of the node failure and take corrective actions.
    - If not, set up the primary and secondary management server. Refer to 6.3

"Changing the management server."

- In case of displaying "Down"  
Check if there's any failure or damage in the nodes and if the package is correctly installed for each product. If any, take corrective actions.

**Symptom 23 : When reading the URL of Java Plug-in by using Netscape Communicator or Netscape Navigator, the message "Click here to get the plugin" is displayed in the Web browser.**

**Corrective action**

Verify the followings;

- If the Java Plug-in is installed.
- If the supported version is updated.

If there is any problem, install Java Plug-in according to "Setting up Java Plug-in" in 3.1.3.2 "Required for the Web-Based Admin View."

Note that the dialogue box appears when clicking the icon on "Click here to get the plugin", so select [Cancel].

**Symptom 24 : When reading the URL of Java Plug-in by using Internet Explorer, the message "Welcome to Web-Based Admin View" is not displayed or the dialog of "Security Warning" (if the Java Plug-in should be installed and executed) is displayed in the Web browser.**

**Corrective action**

Verify the followings;

- If the Java Plug-in is installed.
- If the supported version is updated.

If there is any problem, install Java Plug-in according to "Setting up Java Plug-in" in 3.1.3.2 "Required for the Web-Based Admin View."

Note that when the dialogue box of "Security Warning" appears, select [Cancel].

**Symptom 25 : The japanese character turn into garbage or is not displayed on a screen.**

**Corrective action**

The client might be used where Japanese environment is not set up. Check the environment , and then use the client with proper environment. For details about the recommended display language on your environment, refer to 4.3.1 "Display setup."

## B.2 Collecting Troubleshooting Information

If an error occurs in the Web-Based Admin View, collect the following investigation material and call your Fujitsu systems engineer (SE).

◆ **Web-Based Admin View investigation information**

1. Use WvCnt I to collect investigation information on all management servers and monitoring nodes.
2. Collect the Java Console on the clients.
3. Collect screen hard copies on the clients.

**Note**

- Normally the Java Console screen is not displayed when using the Java plug-ins ("Plugin" is included in the connected URL). Therefore, collect the Java Console only if a problem can be reproduced. For details on collecting the Java Console, refer to B.2.2 "Collecting the Java Console."
- If the SynfinityCluster is installed, collect the investigation information referring to "SynfinityCluster Installation/Administration Guide".

## B.2.1 Executing the wvCntl Command

---

If an error occurs in the Web-Based Admin View, investigation information can be collected with the wvCntl command. Execute these operations on the all the management server and monitoring node. For details on the management server and monitoring node, see the 1.2.2 "System Topology" .

Execute the wvCntl command as follows:

**◆ Operation:**

1. Execute log-in with system administrator authority.
2. Execute the wvCntl command.

As a result, the file "wLogs.tarZ" is generated on the node where the command is executed.

```
# /etc/opt/FJSVwvbs/etc/bin/wvCntl glogs -all
```

```
<the_material_storage_directory_name>
```

```
<the_material_storage_directory_name>:
```

Specify the storage directory of the investigation material with full path. When the directory is not specified, the investigation material is automatically stored on /var/tmp as default.

## B.2.2 Collecting the Java Console

---

The method of collecting the Java Console is done on the client displayed Web-Based Admin View as following. Note that collecting is different depending on the client or connected URL types.

**■ In case of using Java Plug-in ( "Plugin" is included in the connected URL name )****◆ In case of displaying Java Console**

Collect the Java Console for Java Plug-in. If the Java console is not displayed when a problem occurs, information cannot be collected. Note that information may be collected only if the problem is recurring. Reproduce the problem by taking the following procedure and collect the related information:

**< In case of using PC client >**

1. Exit the browser.
2. Select [Start]-[Program]-[Java Plug-in control panel].
3. Click the [Java Plug-in control panel]-[Base] tab, and then select [Java console display].
4. Click <Apply>, and then close the [Java Plug-in control panel].
5. Start browser.

**< In case of using either Solaris Workstation or System Management Console (SMC) >**

1. Exit the browser.

2. Display the Java Plug-in control panel by executing as follows :  
**# <Netscape dir>/j2pi/ControlPanel**  
 <Netscape\_dir>: Specify the Netscape installation directory.  
 For Solaris2.6 or Solaris7, the directory is default "/opt/NSCPcom," and for Solaris8, the directory is default "/usr/dt/appconfig/netscape."
3. Click the [Java Plug-in control panel]-[Base] tab, and then select [Java console display].
4. Click <Apply> and then close the [Java Plug-in control panel].
5. Start browser.

If the problem is reproduced, specify or copy the output information on the Java console and paste it into a text editor such as WordPad.

#### ◆ In case of non-displaying Java Console

After collecting this information, restore the setting with which the Java console is not displayed by taking the following procedure:

##### < In case of using PC client >

1. Exit the browser.
2. Select [Start]-[Program]-[Java Plug-in control panel].
3. Deselect [Java consol display] on the [Java Plug-in control panel]-[Base]tab.
4. Click <Apply>, and then close the [Java Plug-in control panel].
5. Start browser.

##### < In case of using either Solaris Workstation or System Management Console (SMC) >

1. Exit the browser.
2. Display the Java Plug-in control panel with executing as follows :  
**# <Netscape dir>/j2pi/ControlPanel**  
 <Netscape\_dir> : Specify the Netscape installation directory.  
 For Solaris2.6 or Solaris7, the directory is default "/opt/NSCPcom," and for Solaris8, the directory is default "/usr/dt/appconfig/netscape."
3. Deselect [Java consol display] on the [Java Plug-in control panel]-[Base]tab.
4. Click <Apply>, and then close the [Java Plug-in control panel].
5. Start the browser.

#### ■ In case of not using Java Plug-in ( "Plugin" is included in the connected URL name )

##### < In case of using either PC Client, Solaris Workstation, or System Management Console (SMC) >

Collect the Java Console. After the Java Console is displayed, specify or copy the output information on the Java console and paste it into a text editor such as WordPad. Note that the Java Console displaying is different depending on the Web browser. Refer to Help of Web browser for details.

### B.2.3 Collecting screen hard copies

Collect the screen hard copies on the client displayed Web-Based Admin View as following.

Click the PrintScreen button, then paste the target data by using the image editing tool, then store the data as a bit map file or in another format. If the <Detail> button is available on the error dialog, collect the displayed error detail information as well when the <Detail> button is clicked.



### Note

As screen hard copies cannot be collected when using either the Solaris Workstation or the System Management Console (SMC), take notes on the screen contents.



# Glossary

**Active Directory**

Refers to the directory service used with Windows(R) 2000 and which forms the basis of the distribution network of Windows(R) 2000.

**Active node**

Refers to the node on which an active node in the standby class operates.

**Cluster management view**

This software is used for operation from installation to operation management of the cluster system on the Web screen.

**Cookie**

Refers to information that is stored on the client hard disk drive when the client accesses the server with a browser. This enables the server to identify a client who has already accessed.

**DNS**

Abbreviation for Domain Network Service. This is a mechanism that resolves the host name of computer or service itself.

**Group address**

Address for communicating with multiple communication destinations on the IP network.

**Host name**

Refers to the name that is recognized by the communication network.

**Http port**

Refers to the network port that the management Web server (Webcnf) uses to accept a connection from the client.

**Internet Explorer**

Refers to the Web browser manufactured by Microsoft Corporation.

**Java console**

Refers to the console screen for the Java program provided by a Web browser or Java Plug-in. The behavior of the Java program within a client's Web browser is displayed.

**Java Development Kit**

Java basic development kit offered by Sun Microsystems. Java Plug-in software is attached.

**Java Plug-in**

Refers to JavaVM for the Web browser manufactured by Sun Microsystems.

**Java Runtime Environment**

Software set required in order to perform software developed in the Java offered by Sun Microsystems. Java Plug-in software is attached to Java Runtime Environment.

**Management Web server**

Product to provide the WWW server (http server) function for using the Web-Based Admin View.

**Multicast address**

IP address for implementing multicast.

**Netscape**

Refers to the Web browser provided by Netscape Communications Corporation.

**Node**

A single computer (on which a single operating system operates)

**Public LAN**

Refers to the LAN that is used by job applications and the Web-Based Admin View. This is discriminated from a private LAN when the cluster system is constructed.

**RMI function**

Abbreviation for Remote Method Invocation. Remote method invocation function.

**RMI port**

Refers to the network port that enables Web-Based Admin View to perform communications with clients and monitor target nodes.

**Session ID**

Refers to the ID that is used internally by the Web-Based Admin View and the identifier used to identify a connection with clients.

**Standby node**

Refers to the node that is operating as the standby instance of the standby class.

**SynfinityCluster**

Software provided by Fujitsu for cluster configuration.

**SynfinityDisk**

Software provided by Fujitsu to support the management of the disk that performs mirroring.

**Swing Class File**

A Java component provided by Sun Microsystems. Performs control related to graphics.

**User group**

Used to limit the operation and monitoring of each operational management product provided by Web-Based Admin View. This user group, such as wvroot, is registered as a group to be provided in the operating system. The use of Web-Based View is enabled by registering a user ID within this group.

**Web-Based Admin View**

A common base to utilize GUI (operation management view) with SynfinityCluster.

**WWW Server for Admin View**

WWW server for Web-Based Admin View (Web server).

# Index

- A**
- Access method ..... 90, 92
  - Active Directory ..... 119
  - Active node ..... 119
  - Authentication environment setup ..... 72, 113
- C**
- Changing a Http Port Number ..... 30, 85, 105
  - Changing a Network Service Port Number ..... 85
  - Changing an IP Address on the Public LAN ..... 84, 88, 89, 107, 108, 111
  - Changing Java Environment ..... 86, 110
  - Changing RMI Port Numbers ..... 85, 108
  - Changing Settings ..... 83
  - Changing the Look & Feel ..... 37
  - Changing the management server 5, 88, 93, 108, 111, 114
  - Changing the Screen Size ..... 38
  - Changing the Web-Based Admin View settings ..... 81
  - Changing the secondary management server automatic migration ..... 9, 31, 51, 66, 88, 90, 111
  - Client ..... 59
  - Cluster management view ..... 119
  - Cluster Topology of the Web-Based Admin View ..... 5
  - Collecting screen hard copies ..... 117
  - Collecting the Java Console ..... 116
  - Collecting Troubleshooting Information ..... 115
  - Common ..... 32
  - Common Menu ..... 43
  - Common Menu Facilities ..... 34, 113
  - Confirming the Swing Class File Version ..... 26
  - cookie ..... 119
- D**
- Determining the user group ..... 22
  - Display setup ..... 53, 115
  - DNS ..... 119
- E**
- Environment setup ..... 34, 37, 45
  - Environment Setup message ..... 102
  - Environment setup start ..... 47
  - Environment variable ..... 69, 71
  - Environment variable modification ..... 70
  - Environment variable reference ..... 70
  - Event log ..... 63
  - Executing the wvCntrl Command ..... 116
- G**
- Group address ..... 119
- H**
- Host name ..... 119
  - Http port ..... 119
- I**
- Initial Installation of Web-Based Admin View ..... 14
  - Installing Web-Based Admin View ..... 13
  - Internet Explorer ..... 119
  - IP address / Host name ..... 67
- J**
- Java console ..... 119
  - Java Development Kit ..... 119
  - Java Plug-in ..... 119
  - Java Runtime Environment ..... 119
- L**
- Language ..... 53
  - Log & Inactivity timeout ..... 49, 55
  - Log file display ..... 75
  - Logging View ..... 34
  - Logging view startup ..... 75
  - Logical Three-Tier Architecture Logical Three-Tier Architecture ..... 5
  - Login log ..... 61, 76
  - Login log file ..... 74
  - Log reference message ..... 102
  - Log type ..... 74
  - Look & Feel ..... 53
- M**
- Management Web server ..... 119
  - Manual ..... 34
  - Message ..... 97
  - Message reference ..... 97
  - Monitoring node ..... 60
  - Monitoring node trace log ..... 65
  - Multicast address ..... 119
- N**
- Netscape ..... 119
  - Node ..... 120
  - Node environment ..... 66
- Exiting the Web-Based Admin View Menu ..... 36

Notices on system environment setup ..... 51

## O

On the inactivity timeout ..... 49, 55  
Operating the Web-Based Admin View ..... 19  
Operating the Web-Based Admin View  
Screens ..... 37  
Operating the Secondary Management  
Server Dynamically ..... 9  
Operation log ..... 62, 78  
Operation log file ..... 74  
Outline of the Web-Based Admin View ..... 1

## P

Preparations for Starting the Web-Based  
Admin View menu ..... 22  
Preparing the client environment ..... 14, 23, 25  
Preparing the Web browser ..... 25, 113  
Preparing the Web environment ..... 25, 105  
Prerequisite server environment ..... 24  
Primary management server ..... 56  
Product Using Web-Based Admin View ..... 11  
proxy setting ..... 26  
Public LAN ..... 120

## R

Reference and modification by command .... 45, 69  
Referencing Version or Level of the  
Web-Based Admin View ..... 10  
Registering to the User Groups ..... 22  
Required for the Web Browser  
Environment ..... 25, 26, 109, 115  
Restart Web-Based Admin View .... 39, 40, 71, 72,  
84, 85, 86, 88, 91, 94, 101, 103, 106, 108,  
111, 112, 113  
RMI function ..... 120  
RMI port ..... 120

## S

Secondary management server ..... 57  
Server trace log ..... 64  
Session ID ..... 120  
Setting from environment setup screen ..... 91  
Setting Operating Conditions for  
Web-Based Admin View ..... 41  
Setting up Java Plug-in ..... 27, 31, 115  
Setting up the Swing class file ..... 27, 29  
Setting Web-Based Admin View When  
Using SynfinityLink ..... 16  
Setting with a command ..... 88, 89, 94  
Setup by command ..... 90, 92  
Standby node ..... 120  
Starting the Web-Based Admin View  
Menu ..... 21, 30  
Stopping Web-Based Admin View ..... 39, 84, 88  
Swing Class File ..... 120  
Switching the Management Server to Be  
Connected ..... 38, 92

Symptom 1 ..... 105  
Symptom 11 ..... 110  
Symptom 14 ..... 112  
Symptom 16 ..... 112  
Symptom 17 ..... 112  
Symptom 18 ..... 31, 113  
Symptom 2 ..... 105  
Symptom 4 ..... 106  
Symptom 5 ..... 108  
Symptom 7 ..... 108  
Symptom 9 ..... 109  
SynfinityCluster ..... 24, 120  
SynfinityDisk ..... 120  
System environment ..... 51  
System Topology ..... 5

## T

Tentative modification of screen display  
settings (Language, Look & Feel) ..... 37  
Top Menu of the Web-Based Admin View ..... 32  
Troubleshooting ..... 105

## U

Upgrading Web-Based Admin View ..... 15  
User environment ..... 48  
User group ..... 120  
User Group Types ..... 22  
Using Operation Management Products  
with Different Access Methods  
Simultaneously ..... 35  
Using the Management Server in a  
Split-network Environment .. 5, 66, 89, 90, 93,  
108, 111, 112  
Using the Mouse ..... 38

## W

Web-Based Admin View ..... 120  
Web-Based Admin View log reference ..... 34, 73  
Web-Based Admin View menu ..... 15, 32  
Web-Based Admin View message ..... 98  
What is Web-Based Admin View? ..... 3  
WWW Server for Admin View ..... 120



